

**CALIFORNIA SAFETY MANUAL
CODE OF SAFE WORK PRACTICES
ACCIDENT PREVENTION RULES
(RED BOOK)**

Western Line Constructors Chapter, Inc.
N.E.C.A., Inc.



and



Local Union No. 47 and 1245 of International Brotherhood
of Electrical Workers AFL-CIO

Amended July 1, 2020
(Trademark)

Table of Contents

Section 1.0 - General Rules.....	5
1.01 Scope	5
1.02 Education	5
1.03 Knowledge	5
1.04 Enforcement	5
1.05 Emergencies	5
1.06 Amendments	5
1.07 Interpretation	5
1.08 Supplementary Information	6
1.09 Care in Performance of Duties.....	6
1.10 Qualifications for Duty.....	6
1.11 Personal Protective Equipment (PPE).....	6
1.12 Intoxicants	6
1.13 Smoking	7
1.14 First Aid.....	7
1.15 What to Do When an Incident or Accident Occurs.....	7
1.16 Sight Protection	8
1.17 Protection from Dusts, Fumes, Vapors or Gases, and Wildfire Smoke.....	8
1.18 Poisons.....	8
1.19 Explosives	8
1.20 Lights.....	8
1.21 Gasoline	8
1.22 Fire Protection	9
1.23 Welding, Metalizing, Soldering and Use of Open Flames	9
1.24 Compressed Gases.....	10
1.25 Warning Signs, Guards, Barricades, Barriers, Etc.....	10
1.26 Use of Safety Devices.....	11
1.27 Removing Safeguards	11
1.28 Safety Belts, Life Lines, Railings, Etc.	11
1.29 Safe Supports.....	11
1.30 Ladders	11
1.31 Tools	12
1.32 Housekeeping	12
1.33 Lifting Material or Equipment	13
1.34 Packing, Unpacking, Storage, Loading and Unloading of Materials.....	13
1.35 Motor Vehicle Operation.....	14
1.36 Cranes, Hoists and Derricks	14
1.37 Tailboard Briefing	18
1.38 Clearances	19
1.39 Grounding for the Protection of Employees.....	19
Section 2.0 - Electric Transmission and Distribution Overhead.....	20
2.01 Scope	20
2.02 Energized High-Voltage Conductors or Apparatus - Journeyman Lineman.....	20
2.03 Energized Low-Voltage Conductors or Apparatus	20
2.04 Use of Cell Phones or Other Electronic Devices	20
2.05 Working Distance.....	20
2.06 Pole-Mounted Apparatus	23
2.07 De-Energizing, Grounding, and Bonding Lines and Equipment for Employee Protection	23

2.08	Use of Rubber Protective Equipment	26
2.09	Climbing Equipment	27
2.10	Working in Elevated Positions	28
2.11	Belts and Safety Straps and Harnesses	29
2.12	Hand Lines	29
2.13	Testing Poles and Stubs	30
2.14	Blasting Pole Holes	30
2.15	Setting or Removing Poles	31
2.16	Common Neutral Systems	31
2.17	Wire Stringing	32
2.18	Capacitors	32
2.19	Apparatus Leads	32
2.20	Banked Secondaries.....	32
2.21	Rubber Gloving to 21kV.....	33
Section 3.0 - Use, Maintenance and Care of Live Line Tools		38
3.01	Use	38
3.02	Care and Maintenance	38
Section 4.0 - Metal Tower Construction.....		39
4.01	Assembling and Erecting.....	39
4.02	Stringing, Removing, and Handling Conductors	39
4.03	Rigging	41
4.04	Grips.....	41
4.05	Pulling Line.....	41
4.06	Clipping	41
Section 5.0 - Entering and Working in Underground Structures		42
5.01	Qualified persons.....	42
5.02	Safeguards	42
5.03	Safe Work Practices	42
5.04	Working on Cable or Apparatus	43
5.05	Moving Cables	44
5.06	Static Charge on De-Energized Cables	44
5.07	Grounding Procedures.....	44
Section 6.0 - Civil Underground Operations.....		46
6.01	Underground Installations.....	46
6.02	Protection from Hazards Associated with Water Accumulation	46
6.03	Stability of Adjacent Structures	46
6.04	Protection of Employees from loose Rock or Soil.....	47
6.05	Inspections.....	47
6.06	Fall Protection.....	47
6.07	Access and Egress	47
6.08	Exposure to Vehicular Traffic.....	48
6.09	Exposure to Falling Loads	48
6.10	Warning Systems for Mobile Equipment.....	48
6.11	Hazardous Atmospheres.....	48
6.12	Chipping Procedures when Energized Cables are Present	49
Section 7.0 - Protection of Employees in Excavations		50
7.01	General	50

7.02	Design of Sloping and Benching Systems.....	50
7.03	Design of Support Systems, Shield Systems, and Other Protective Systems.....	55
7.04	Materials and Equipment	63
7.05	Installation and Removal of Support.....	63
7.06	Sloping and Benching Systems	64
7.07	Shielding Systems.....	64
7.08	Soil Classification.....	64
7.09	Sloping and Benching.....	67
Section 8.0 - Energized Switchyards and High Voltage Substations		69
8.01	Work Near Energized Equipment and Facilities.....	69
Section 9.0 - Procedures for Helicopter Work		71
9.01	Safety.....	71
9.02	Equipment and Tools	72
9.03	Receiving Loads While Working Aloft.....	73
9.04	Cargo Loading and Handling	74
9.05	Helicopter Skid and Tower Aerial Hover Transfer	75
9.06	Working from the Helicopter Skid	76
9.07	Helicopter Rules for Human External Cargo (HEC)	76

Effective January 1, 1985
 Amended January 1, 1990
 Amended January 1, 1994
 Amended January 1, 2000
 Amended July 1, 2003
 Amended April 1, 2004
 Amended August 3, 2004
 Amended August 17, 2005
 Amended March 29, 2007
 Amended December 10, 2007
 Amended June 17, 2009
 Amended October 15, 2012
 Amended March 11, 2020
 (Trademark)

Section 1.0 - General Rules

1.01 Scope

These accident prevention rules shall be complied with by every employee of the Company. Acceptance of employment by an employee constitutes acceptance of these rules. The employer shall reserve the right to supplement these rules provided they meet and/or exceed the current rules in this document and the requirements per section 1.07 of this document.

1.02 Education

In addition to any current: safety, accident prevention, and educational or training program, each supervisor or foreman shall make certain all employees under their jurisdiction are instructed and advised concerning the applicable rules and their application.

1.03 Knowledge

Each employee of the Employer shall be required to know and understand the rules which apply to the work each person is performing.

1.04 Enforcement

- (a) Employees acting in a supervisory capacity either regularly or temporarily shall require all employees working under their jurisdiction to comply with all applicable safety instructions, safe practices, and safety rules.
- (b) Any employee has the right to refuse to perform work that would violate this manual or any occupational safety or health standard or order where such violation would create a real and apparent hazard to the employee or other employees.
- (c) Any safety device, tool or equipment which upon inspection is found unsafe or defective shall be removed from service.

1.05 Emergencies

In the event of an emergency which may result in a serious personal injury, a supervisor, foreman or employee in charge may temporarily modify or suspend any of these rules as they may consider necessary to permit proper handling of the emergency. In any such case: the person so acting shall be fully accountable for their actions.

1.06 Amendments

Revisions or amendments may only be made in the manner in which these rules were originally issued and shall be effective on the date of their issuance.

1.07 Interpretation

This manual shall be interpreted to bring about maximum compliance and safe conduct and shall take precedence over any conflicting instructions that are less stringent.

In addition to its own accident prevention rules and safe practices, the employer and its employees in the performance of their work are subject to the regulations of customer and governmental agencies including federal, state, county, and city. The employer shall ensure all applicable provisions of governmental regulations are

complied with.

1.08 Supplementary Information

Additional instructions and information relating to safe performance of work as issued through the medium of letters, operating instructions, bulletins, etc., shall be used to supplement these fundamental accident prevention rules as necessary and shall be made available to all employees.

1.09 Care in Performance of Duties

- (a) Each employee shall use reasonable care in the performance of their duties and act in such a manner as to ensure at all times maximum safety to themselves, their fellow employees and the public.
- (b) Employees shall not engage in practical jokes, scuffling, "horse play", or the urging of persons to take unnecessary chances.

1.10 Qualifications for Duty

- (a) No employee shall attempt work for which they are not mentally and physically fit.
- (b) Any employee in charge having reasonable grounds to suspect an employee under their supervision is either mentally or physically unfit for duty, shall prohibit such employee from working until satisfactory medical, or other evidence indicating fitness for duty is obtained.

1.11 Personal Protective Equipment (PPE)

The employer shall assure that all required safety devices and safeguards, whether employer or employee provided, including personal protective equipment for the eyes, face, head, hand, foot, and extremities (limbs), protective clothing, respiratory protection, protective shields and barriers, comply with the applicable OSHA standards and are maintained in a safe, sanitary condition.

- (a) Each employee shall wear a long sleeve shirt (sleeves rolled down and/or buttoned), long pants and work boots at all times.
- (b) Employees exposed to the hazards of flames or electrical arcs shall wear approved flame resistant (FR) long sleeve shirts (sleeves rolled down and/or buttoned) or other FR clothing as required. Synthetic clothing (For example: acetate, nylon, polyester and rayon) other than FR designated clothing, will not be used under any circumstances. All undergarments worn will be made of natural fibers.
- (c) Employees working in areas where there is a possible danger of head injury from impact, falling or flying objects, electrical shock and burns, or where specifically posted, shall be protected by the appropriate class hard hat ANSI Z89.1. (Class E)

1.12 Intoxicants

- (a) Use of intoxicants or illegal drugs by any employee during working hours is prohibited, any violation will be sufficient cause for dismissal.
- (b) Any employee reporting for duty while under the influence of intoxicants or illegal drugs shall not be allowed to assume their duties.

1.13 Smoking

- (a) Employees shall not smoke in proximity to flammable liquids, explosives or gases, or where "No Smoking" signs are displayed.
- (b) Matches, cigars, cigarettes, tobacco or other substances must not be discarded while still burning except when placed in a proper receptacle or otherwise disposed of safely.
- (c) All matches or other sources of ignition shall be removed from the person of any employee before entering an explosive or combustible area.
- (d) Smoking shall not be permitted in areas indicated as danger zones or areas closed by federal, state, county or city officers.
- (e) Smoking shall not be permitted in fire areas and/or during Red Flag conditions except in designated smoking areas or in a 10' clearing which is void of all grasses and vegetation.

1.14 First Aid

- (a) Employees shall maintain current certification in both First Aid and CPR. Certifications must be equal to that provided by the American Red Cross, Coyne First Aid or MSHA and may not be obtained through an on-line provider.
- (b) Employers shall provide First Aid kits which meet area regulatory requirements and shall be maintained and readily available to all employees.

1.15 What to Do When an Incident or Accident Occurs

The following rules covering the reporting and preliminary investigation of all incidents or accidents shall be strictly observed:

- (a) Injury to Employees.
 - (1) When possible, at least one employee should stay with the injured person to render first aid such as; controlling bleeding, applying artificial respiration and treating for the symptoms of shock, until medical attention is available.
 - (2) When a serious injury to or death of an employee occurs while on duty, the first employee having knowledge shall seek the help of Emergency Medical Services by the fastest means of communications available.
- (b) Incident or Accident Investigation.
 - (1) No equipment, machinery, tools or evidence of the incident or accident, shall be removed from the site, unless a hazard or dangerous situation exists, until the Employer can secure accurate measurements, photographs and/or other vital information regarding the incident or accident.
 - (2) It is the employers' responsibility to notify the union of all serious incidents, accidents or fatalities within 24 hours.
- (c) Automobile Incidents or Accidents.

In all incidents or accidents involving the operation of an Employer vehicle, the Employee (driver) shall follow all federal, state and local laws, as well as employer rules and policies.

1.16 Sight Protection

Approved eye-protective devices are provided on jobs that require eye protection. Such devices should fit properly, be kept clean at all times, and shall be worn when an employee is engaged in, or in the vicinity of work involving jobs where there is danger of eye injury and shall meet ANSI Z87.1

1.17 Protection from Dusts, Fumes, Vapors or Gases, and Wildfire Smoke

- (a) Where it is impracticable to eliminate harmful quantities of dusts, fumes, vapors or gases, every employee in the zone of contamination must be protected in a manner that will ensure a supply of clean air. Otherwise, only approved respiratory equipment used by properly trained and qualified employees shall be used.
- (b) When work is performed in areas where it can reasonably be anticipated that employees will be exposed to wildfire smoke, the supervisor in charge of the job shall:
 - (1) Determine whether there are harmful levels of air borne particulate matter in the area by checking the Air Quality Index (AQI) prior to the start of work and periodically during the job. (AQI levels can be determined by checking the U.S. EPA AirNow website)
 - (2) If the AQI for particulate matter is 150 or higher, employees must be provided respirators such as N95 masks for voluntary use.

1.18 Poisons

Before handling poisonous, infectious, or corrosive substances, such as acids, solvents, leads, etc., employees should thoroughly familiarize themselves with the hazards involved and utilize all necessary precautions, protective devices and/or equipment.

1.19 Explosives

Only authorized and experienced employees shall handle explosives, and then only in accordance with approved and lawful methods.

1.20 Lights

- (a) No artificial light, except an Employer issued light or an approved explosion-proof fixture, shall be used near escaping gas, gasoline, or other flammable vapors, or when entering a room or enclosure suspected of containing an explosive atmosphere.
- (b) Dark places, such as basements, cellars, etc., shall not be entered without proper light; the use of matches or other open flames is strictly forbidden.
- (c) When workers are working at night, adequate lighting shall be provided by the Employer.

1.21 Gasoline

- (a) Gasoline shall be stored, handled and transported only in approved containers, and extreme care must be used at all times to prevent ignition. In addition, employees shall familiarize themselves with and observe local ordinances relative to such storage.

- (b) When pouring or pumping gasoline from one container to another, contact shall be maintained between the pouring and receiving containers.

1.22 Fire Protection

- (a) Employees shall be familiar with instructions relating to fire prevention and suppression, and with the location and use of all firefighting equipment in the location where they are regularly employed.
- (b) All fire apparatus shall be maintained in serviceable condition and accessible at all times.
- (c) Carbon tetrachloride fire extinguisher shall not be used.

1.23 Welding, Metalizing, Soldering and Use of Open Flames

- (a) Open flames shall not be brought near to, welding processes, brazing, flame cutting, or soldering done on any empty container, tank, or other vessel which has, or may have, previously contained a flammable or explosive substance.
- (b) Welding processes, flame cutting, brazing, metalizing, soldering and the use of open flames on vessels subject to possible ignition of contents, shall be done in accordance with approved procedures by fully qualified personnel who shall observe the following additional precautions:
 - (1) Keep away from vessel openings as far as possible.
 - (2) Provide suitable fire protection equipment adjacent to the work.
 - (3) Hazardous areas shall be designated by signs and protected by approved barricades as required.
- (c) It shall be the responsibility of the welder to see that, where practical, screens are properly placed to prevent eye injury to fellow workers and on-lookers. Helpers shall wear suitable eye protection when assisting in welding.
- (d) Whenever lead, cadmium, galvanized or other toxic fume producing material is welded, burned or otherwise heated to such a degree that fumes from the metal or its fluxes are generated, the work shall be ventilated so that the workers performing the operation are not exposed to hazardous concentrations of fumes, or the workers shall be protected by approved respiratory equipment. If respiratory equipment is required to protect workers performing the operation, the following additional precautions shall be observed:
 - (1) Sufficient ventilation shall be provided for the protection of others to prevent accumulations of harmful quantities of fumes in the work area; or
 - (2) The operation shall be isolated; or
 - (3) The work shall be performed outdoors, in such a location that fumes will not enter any building in harmful quantities.
- (e) The use of open flames in battery rooms is prohibited except under the direct supervision of qualified and experienced personnel, and then only after the room has been well ventilated.

1.24 Compressed Gases

- (a) Oil or grease shall not be allowed to come in contact with valves, regulators, or any other parts of oxygen cylinders or apparatus. (Oxygen contacting oil or grease may cause an explosion.)
- (b) Portable gas cylinders or containers shall be handled with extreme care and shall be stored in a suitable, well ventilated location, properly secured in a vertical position with valve cap in place, except one-ton chlorine cylinders which shall be stored horizontally.
- (c) Portable gas cylinders or containers shall not be exposed to excessive heat. Sparks and flames shall always be kept away from such cylinders or containers.
- (d) Oxygen cylinders shall not be stored near cylinders containing flammable gases (hydrogen, butane, propane, acetylene, etc.) or with oils, greases or flammable liquid.
- (e) All connections to piping, regulators, and other appliances shall be kept tight to prevent leakage. Should leaks develop, never test with an open flame. When cylinders or containers are not in use, always keep valves tightly closed.
- (f) Compressed gases shall not be used from a cylinder or cylinder manifold or other container unless an acceptable pressure-regulating device is installed on the cylinder, valve or manifold. Regulators shall not be required with fuel gases used from cylinders through torches or other devices, which are equipped with shut-off valves.
- (g) When shipping cylinders of compressed gases, the valves shall be protected by:
 - (1) Securely attached metal caps;
 - (2) Boxing or crating the cylinders so as to give proper protection to the valves, or,
 - (3) By loading the cylinders compactly in an upright position and securely bracing them.
- (h) Compressed gas or welding fuel-gas cylinders in portable service shall be securely fastened to suitable trucks in an upright position with valves tightly closed before moving.

1.25 Warning Signs, Guards, Barricades, Barriers, Etc.

- (a) As applicable, approved warning signs, barriers, barricades, guards, cones and flags shall be placed and properly maintained wherever hazards exist due to moving or stationary machinery or vehicles, exposed energized parts, open excavations, construction operation, open manholes or handholes, and similar exposures. In addition, lights and/or other illuminating devices shall be used at night, as required.
- (b) Warning signs, barricades and flagman shall be in compliance with the governing agency having jurisdiction over the jobsite location.
- (c) Where pedestrian or vehicular traffic is involved, and conditions require it, properly trained and equipped flagmen must be stationed to warn or direct traffic; however, the flagmen should exercise extreme care in the performance of their duties, and avoid unnecessary direction of traffic. Where conditions warrant, an employee shall be stationed at the surface to guard open manholes, pits, vaults or excavations.

1.26 Use of Safety Devices

All safety devices furnished by the Employer shall be properly used by all employees as required. These devices will be regularly tested as required and kept in good repair by the Employer, but this will not relieve the employee of the responsibility of using only those in good condition.

1.27 Removing Safeguards

- (a) Safeguards shall not be removed except on approval of the employee in charge.
- (b) Where regular safeguards are removed, they shall be replaced, or suitable temporary guards provided before returning to normal operation.

1.28 Safety Belts, Life Lines, Railings, Etc.

- (a) Employees shall use approved harnesses, safety belts and straps, lifelines or other adequate protection as required when working in elevated positions.
- (b) It shall be the duty of each employee to inspect each safety device prior to use, whether furnished by the Employer or Employee and they shall only use those that are in good condition.

1.29 Safe Supports

- (a) No employee, material or equipment shall be supported on any portion of a tree, pole structure, scaffold, ladder, walkway, or other elevated structure, crane or derrick, etc., without it first being determined that such support is adequately strong and properly secured.
- (b) Scaffolding shall be of sufficient strength and rigidity to support four times the weight of men and material to which it will be subjected; that is, it shall have a safety factor of at least four.
- (c) Scaffolding systems shall comply with applicable federal and state safety orders.

1.30 Ladders

- (a) When working from a portable ladder, the ladder shall be securely placed, held, tied, or otherwise made secure to prevent slipping or falling.
- (b) Care shall be used in placing ladders. Where possible, the horizontal distance from the top support to the foot of the ladder shall be one-quarter of the working length of the ladder (the length along the ladder between the foot and the top support) 4:1 Ratio.
- (c) When practical an extension or straight ladder must extend a minimum of 3' above the point of support.
- (d) Ladders shall not be placed in front of doors opening toward the ladder unless the door is secured open, locked or guarded.
- (e) The employee shall face the ladder and shall use 3 points of contact when ascending and descending.
- (f) When standing on a ladder, the employee shall not lean to one side while working unless the ladder is adequately secured.
- (g) An employee shall not stand on the top platform of stepladders or the step immediately below the top platform.

- (h) Ladders with weakened, broken or missing steps, broken side rails, or otherwise defective, shall be removed from service and tagged.
- (i) All portable ladders, except special purpose ladders, such as tower ladders and metal manhole ladders, shall be equipped with non-slip bases and care shall be exercised in placing them. Blocking or lashing or having the ladder held by someone may be required, especially upon oily, metal, or concrete surfaces.
- (j) Wire truss portable ladders shall not be used.
- (k) Portable metal ladders shall not be used in the vicinity of electric circuits. Any such ladders used for authorized purposes shall be legibly marked "Caution--Do Not Use Around Electrical Equipment."
- (l) Benches, boxes, tables or other makeshift substitutes shall not be used as ladders.
- (m) Wooden ladders shall be finished with clear shellac, varnish or other clear finish only. Paint shall not be used which might obscure a defect in the wood.

1.31 Tools

- (a) Employees shall use proper tools suitable for the job in progress and only those in good repair. Defective tools shall be removed from service and tagged.
- (b) Proper handles shall be fitted to tools where required.
- (c) Tools and other materials shall not be left lying in elevated positions, unless protected from falling.
- (d) Cutting tools shall be kept properly sharpened and cutting edges guarded with scabbards or other safe storage provided when not in use.
- (e) Metallic tapes or metallic rules shall not be used near exposed energized electrical equipment. Cloth tapes with metal reinforcing shall not be used under any circumstances.

1.32 Housekeeping

- (a) Combustible materials, such as oil-soaked and paint-covered rags, waste, shavings, packing and rubbish shall not be allowed to accumulate on benches, bins, floors, yards, or vehicles, except in suitable containers in areas provided, therefore.
- (b) Floors, stairways and platforms shall be reasonably free of dangerous projections or obstructions and shall be maintained in good repair, and reasonably free from oil, grease, or water. Where the type of operation necessitates working on slippery floor areas, such surfaces shall be protected against slipping by the use of mats, grates, cleats or other methods employed to provide equivalent protection. Floors, stairways and platforms shall be constructed and maintained to safely support the loads to which they are subjected.
- (c) Stairways, aisles, exits, roadways and walkways in material storage areas shall be kept reasonably clear and free from obstructions, depressions and debris.
- (d) Material and supplies shall be stored in an orderly manner to prevent their falling or spreading and to eliminate tripping and stumbling hazards.
- (e) Compressed air shall not be used for cleaning purposes, unless an approved pneumatic blowgun is used, limiting pressure to 30 psi.

- (f) Compressed air shall not be used to clean the clothing or hair, or be turned against any person for any reason.

1.33 Lifting Material or Equipment

- (a) When lifting, take a firm grip; secure good footing; place the feet a comfortable distance apart; bend the knees; keep the back straight; and lift with the leg muscles.
- (b) Never carry a load that obstructs the vision.
- (c) Use gloves or hand pads as required when handling materials.
- (d) Seek help when needed. Use cranes or hoists for lifting heavy loads. Keep out from under suspended loads.

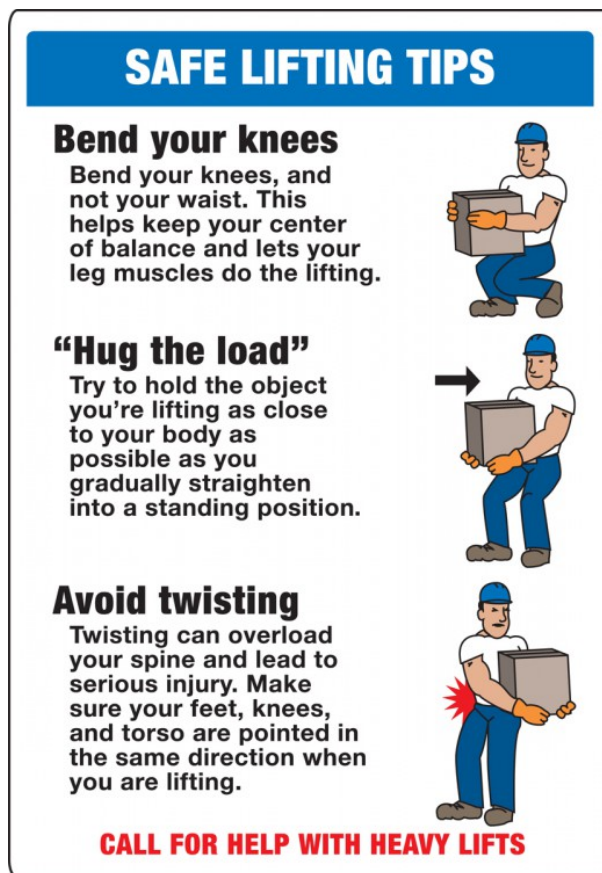

1.34 Packing, Unpacking, Storage, Loading and Unloading of Materials

- (a) Nail points, ends of wires or bands shall not be left exposed when packing or unpacking boxes, crates, barrels, or other containers.
- (b) Nails shall be removed from loose lumber, the points bent down, or the lumber shall be disposed of so that

it will not become a hazard.

- (c) Sharp or pointed articles shall be so stored as to prevent persons from coming in contact with the sharp edges and points.
- (d) Care shall be exercised when packing or unpacking glassware, porcelain and other fragile objects which may have sharp edges.
- (e) Loads shall not be handled from the street side of a vehicle if it can be avoided.
- (f) Special regulations and instructions governing the loading and unloading of poles, pipes, etc., shall be strictly observed in every case.

1.35 Motor Vehicle Operation

- (a) Drivers of vehicles shall be familiar with and obey all State Vehicle Codes, local traffic rules and ordinances, traffic control signs, posted speed limits, parking restrictions, cell phone restrictions and all Employer rules and regulations governing vehicle operation.
- (b) Employees shall not ride on fenders, running boards, side rails, truck bed or on top of vehicles.
- (c) Employees shall ride in the space provided in employer vehicles and shall not ride with their legs hanging out of the rear or side of any vehicle.
- (d) All sharp tools, such as saws, chisels, axes, knives, etc., carried on vehicles shall be so stored or guarded to prevent injury to workers.
- (e) Before proceeding, drivers shall make certain that all loads are properly secured, that riders are properly located to prevent falling from the vehicle and are not exposed to hazards from shifting loads.
- (f) Employees shall not get on or off vehicles in motion.
- (g) Drivers shall not permit more employees to ride on the seat than the number for which the seat was constructed.
- (h) Where provided, employees shall use automotive seat belts, properly fastened, at all times while driving or riding in the following Employer vehicles:
 - (1) All passenger vehicles and trucks.
 - (2) Construction equipment, when the equipment is being "roaded."
 - (3) Construction equipment, (such as forklifts, tractors, loaders, trenchers and tampers) when provided with both seat belts and a canopy, roll bars, or similar roll over protection.

(Exception: Seat belts need not be worn by employees using this type of equipment when it is necessary for the employee to operate the equipment from a position other than sitting in the normal seat provided.)

1.36 Cranes, Hoists and Derricks

- (a) Cranes, hoists, and derricks shall be operated only by a certified and qualified person.
- (b) When mobile hoists, cranes, booms, or other similar lifting devices are used near energized equipment, all

persons shall remain in the clear until the equipment is in a safe position. The person in charge shall check and determine that all persons remain in the clear while the vehicle is being moved or the boom is being repositioned.

- (c) Employees shall not ride on loads suspended from cranes, hoists, and derricks.
- (d) A sign shall be posted in the cab of all outdoor portable cranes, hoists, and derricks reading essentially as follows: "Unlawful to operate this equipment within 10 feet of high voltage lines of 50,000 volts or less. The above clearances do not apply to authorized work by qualified persons on or near energized high-voltage conductors or apparatus."
- (e) Operators shall not move loads over the heads of workers or others unless authorized by the employee in charge. Operators shall not leave cranes, hoists, or derricks unattended while load is suspended, unless suspended over a barricaded area, blocked or otherwise supported from below during repair or emergency.
- (f) No crane, hoist, or derrick shall be loaded in excess of its rated capacity.
- (g) Crane, hoist, or derrick operators shall take signals only from the person designated by the employee in charge.
- (h) Uniform hand signals shall be used to signal overhead traveling cranes, and uniform signals for derrick and crane operators shall be used. The appropriate chart shall be conspicuously posted in the vicinity of hoisting operations (cage or cab if so equipped) depicting and explaining the system of signals to be used.

Uniform Hand Signals for Overhead Traveling Cranes

OVERHEAD CRANE HAND SIGNALS



HOIST



LOWER



BRIDGE TRAVEL



TROLLEY TRAVEL



STOP



EMERGENCY STOP



MULTIPLE TROLLEYS



MOVE SLOWLY



MAGNET DISCONNECTED

Uniform Hand Signals for Mobile Type Cranes and Derricks

MOBILE CRANE HAND SIGNALS



HOIST



LOWER



USE MAIN HOIST



USE WHIPLINE



RAISE BOOM



LOWER BOOM



MOVE SLOWLY



RAISE THE BOOM
LOWER THE LOAD



LOWER THE BOOM
RAISE THE LOAD



SWING



STOP



EMERGENCY STOP

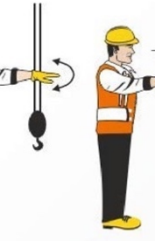

TRAVEL



DOG EVERYTHING



TRAVEL
(BOTH TRACKS)



TRAVEL
(ONE TRACK)



EXTENDED BOOM



RETRACT BOOM

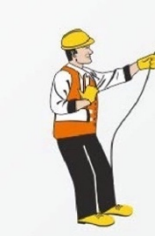

EXTEND BOOM
(ONE HAND)

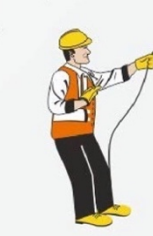

RETRACT BOOM
(ONE HAND)

- (i) Portable cranes, hoists and derricks shall be positioned, equipped, protected, and/or operated so that no part comes closer to energized power lines than indicated in the below table:

TABLE A—MINIMUM CLEARANCE DISTANCES

Voltage (nominal, kV, alternating current)	Minimum clearance distance (feet)
up to 50	10
over 50 to 200	15
over 200 to 350	20
over 350 to 500	25
over 500 to 750	35
over 750 to 1,000	45
over 1,000	(as established by the utility owner/operator or registered professional engineer who is a qualified person with respect to electrical power transmission and distribution).

Note 1: The value that follows "to" is up to and includes that value. For example, over 50 to 200 means up to and including 200kV.

Note 2: These clearances do not apply to such equipment when used for authorized work on overhead and underground conductors, structures, or appurtenances by Journeyman Lineman or qualified persons under the observation of a Journeyman Lineman/Cable Splicer and/or a Substation Technician.

1.37 Tailboard Briefing

Before starting each job, the employee in charge shall conduct a Tailboard (pre-job briefing). The tailboard shall be in writing and signed by all personnel involved with the project. The purpose is to involve all personnel to discuss the job process and identify hazards and how to eliminate or control them. Where multiple crews are involved a master tailboard shall be conducted prior to individual crew tailboards. The following items shall be addressed and documented during the conference:

- (a) Each person will understand the purpose of the job. In other words, what they are going to accomplish.
- (b) Each person will understand what they are to do.
- (c) Each person will understand what the other members of the crew are to do.
- (d) Each person will understand the manner in which the employee in charge intends to carry out the job.
- (e) Each person will understand the hazards or trouble spots involved and will know how the employee in charge is proposing to overcome such problems.
- (f) Each person will be aware of the physical location of the job, to relay that information to emergency responders in the event of an accident.
- (g) Each person will know the location of the nearest Medical / Trauma care facility.

Additional briefings shall be conducted whenever: tasks, key steps, the scope of work changes, personnel and/or environmental changes or hazards differ from the original briefing. Additional briefings shall also be held after extended work pauses such as work breaks, weather delays etc.

1.38 Clearances

Before any employee starts work on any equipment or apparatus for which clearances are required, the employee shall either obtain a clearance, or report to and work under a qualified employee who holds a clearance on the equipment or apparatus involved.

LOTO: If clearance procedures are not applicable lock out/tag out procedures shall be implemented for hazardous energy control.

1.39 Grounding for the Protection of Employees.

- (a) Application. This section applies to grounding of transmission, and distribution lines and equipment for the purpose of protecting employees. Subsection (f) of this section also applies to protective grounding of other equipment as required elsewhere in this Article.
- (b) General. For any employee to work transmission and distribution lines or equipment as deenergized, the person in charge shall ensure the lines or equipment are deenergized and shall ensure proper grounding of the lines or equipment as specified in subsections (c) through (g) of this section.
- (c) Testing. Tests shall be conducted to ensure that conductors or equipment have been deenergized before employees install any ground on lines or equipment.
- (d) Guards or barriers shall be installed as necessary to prevent contact with another exposed energized conductor or equipment.
- (e) Equipotential Zone. Temporary protective grounds and bonds shall be placed at such locations and arranged in such a manner that the person in charge can demonstrate will prevent each employee from being exposed to hazardous differences in electric potential.
- (f) Connecting and Removing Grounds.
 - (1) Order of connection. The person in charge shall ensure that, when an employee attaches a ground to a line or to equipment, the employee attaches the ground-end connection first and then attaches the other end by means of a live-line tool.
 - (2) Order of removal. The person in charge shall ensure that, when an employee removes a ground, the employee removes the grounding device from the line or equipment using a live-line tool before he or she removes the ground-end connection.
- (g) Removal of Grounds for Test. The person in charge may permit employees to remove grounds temporarily during tests. During the test procedure, the person in charge shall ensure that each employee uses insulating equipment, shall isolate each employee from any hazards involved, and shall implement any additional measures necessary to protect each exposed employee in case the previously grounded lines and equipment become energized.

Section 2.0 - Electric Transmission and Distribution Overhead

2.01 Scope

These rules shall apply to all personnel engaged in overhead electric Transmission or Distribution work.

2.02 Energized High-Voltage Conductors or Apparatus - Journeyman Lineman

Journeyman Lineman working on, near and including above energized lines or equipment of over 600 volts shall be assisted by another journeyman lineman or hot apprentice, one to one, on the same pole, a suitable aerial insulated platform, structure or location. It is also permissible for the work to be performed by one journeyman lineman/hot apprentice on the pole and one journeyman lineman/hot apprentice in a suitable aerial insulated platform. (Two separate poles or structures may be considered one for the purpose of this rule if both men can step to the other pole or structure without descending to the ground to render immediate assistance.)

During the time work is being done on, near, or above energized conductors or parts of equipment connected to high-voltage systems, a Journeyman Lineman, or Hot Apprentice shall be in close proximity at each work location.

- (a) Act primarily as an observer for the purpose of preventing an incident or accident, and
- (b) Render immediate assistance in the event of an incident/accident.

Foreman. While live line work is in progress, the foreman's sole responsibility shall be to observe activities from the ground.

2.03 Energized Low-Voltage Conductors or Apparatus

No employee shall touch any exposed conductor or apparatus energized at less than 250 volts, phase to ground, unless suitable personal protective equipment such as approved rated insulated gloves or tools are used. For voltages of 250 volts to 600 volts the use of approved rated insulated gloves is mandatory. Leather gloves are not considered an approved insulating device.

2.04 Use of Cell Phones or Other Electronic Devices

The use of non-job-related electronic devices (e.g. Cell Phones, Radios, Bluetooth speakers, mp3 players etc.) or any other device which may cause distraction or disrupt safe communication shall not be used while energized work is being performed.

2.05 Working Distance

The following table lists the minimum working distance from energized conductors or apparatus, which are not properly covered with approved protective equipment. This includes extended reach, falling, and material or equipment whether insulated or not.

Nominal voltage in kilovolts	Distance: Phase to ground exposure	Distance Phase to Phase exposure
0.05 to .300	Avoid contact	Avoid contact
.301 to 1.0	1'9" (0.33m)	1'9" (0.33)
1.1 to 15.0	2'-2" (0.65m)	2'-3" (0.68m)
15.1 to 36.0	2'-7" (0.77m)	3'-0" (0.89m)
36.1 to 46.0	2'-10" (0.84m)	3'-3" (0.98m)
46.1 to 72.5	3'-4" (1.00m)	4'-0" (1.20m)
72.6 to 121.0	3'-9" (1.13m)	4'-8" (1.42m)
121.1 to 145.0	4'-4" (1.30m)	5'-5" (1.62m)
145.1 to 169.0	4'-10" (1.46m)	6'-5" (1.92m)
169.1 to 242.0	6-8" (2.01m)	10'-2" (3.08m)
242.1 to 362.0	11-3" (3.41m)	18'-2" (5.52m)
362.1 to 550.0	16.8" (5.07m)	27'-1" (8.24m)
550.1 to 800.0	22.7" (6.88m)	37'-5" (11.38m)

Altitude	Correction Factor
3,000' (900m)	1.00
4,000' (1,200m)	1.02
5,000' (1,500m)	1.05
6,000' (1,800m)	1.08
7,000' (2,100m)	1.11
8,000' (2,400m)	1.14
9,000' (2,700m)	1.17
10,000' (3,000m)	1.20
12,000' (3,600m)	1.25
14,000' (4,200m)	1.30
16,000' (4,800m)	1.35
18,000' (5,400m)	1.39
20,000' (6,000m)	1.44

NOTE: Applicable minimum approach distance may vary based on customer transient overvoltage (TOV) studies. If TOV studies are available refer to the minimum approach distances provided by the customer.

- (a) When operated by a Non- Qualified Person, mobile cranes, hoists and derricks shall be positioned, equipped, protected, and/or operated so that no part comes closer to energized power lines than indicated in the below table:

TABLE A—MINIMUM CLEARANCE DISTANCES

Voltage (nominal, kV, alternating current)	Minimum clearance distance (feet)
up to 50	10
over 50 to 200	15
over 200 to 350	20
over 350 to 500	25
over 500 to 750	35
over 750 to 1,000	45
over 1,000	(as established by the utility owner/operator or registered professional engineer who is a qualified person with respect to electrical power transmission and distribution).

Note 1: The value that follows "to" is up to and includes that value. For example, over 50 to 200 means up to and including 200kV.

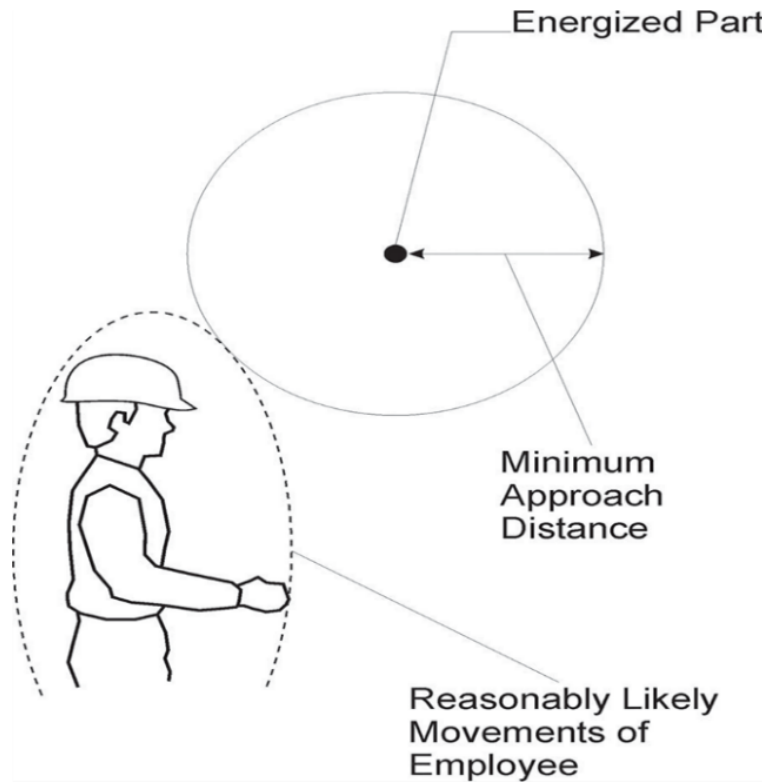

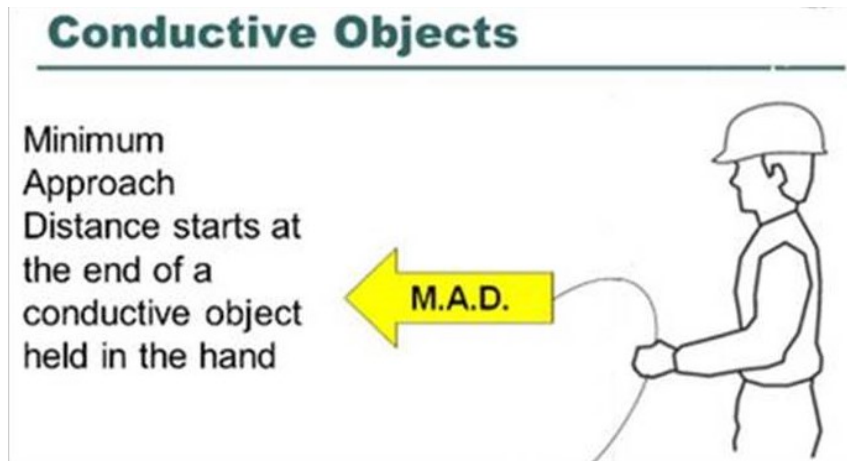

- (b) Nothing in this rule shall prohibit working on conductors or apparatus energized up to 21,000 volts, normal phase to phase, with approved protective equipment.
- (c) The above safe working distance does not apply to energized conductors or apparatus protected by a suitable barrier or properly covered with approved protective devices. However, intentional contact shall not be made with protective covering, except for installation or removal.

2.06 Pole-Mounted Apparatus

- (a) All cutouts and disconnects shall be operated with a fuse or switch stick or approved telescoping live-line tool. When using these tools in conjunction with a load break tool the use of a telescoping device extended in excess of 15' is prohibited.
- (b) Contact with energized transformer, capacitor, regulator or oil switch cases, bond wires, hardware supporting primary voltage insulation and other apparatus shall be avoided except when tested and grounded or worked upon with approved devices.
- (c) Overhead Terminations of underground cables (Potheads) shall not be transferred while energized.

2.07 De-Energizing, Grounding, and Bonding Lines and Equipment for Employee Protection

De-Energizing Lines and Equipment

- (a) This section applies to the deenergizing of transmission and distribution lines and equipment for the purpose of protecting employees.
- (b) General: Each utility system may operate with specific rules and procedures regarding clearance of their facilities, employees shall follow the operating procedures of the individual customer and/or utility.
- (c) Deenergizing Lines and Equipment:
 - (1) The employee in charge shall make a request of the system operator to deenergize the particular section of line or equipment. The employee in charge is responsible for the clearance.
 - (2) Open Disconnecting Means: The employee in charge shall ensure all air switches, disconnectors,

jumpers, taps, and other means through which known sources of electric energy may be supplied to the particular lines and equipment to be deenergized are open. The employee in charge shall render such means inoperable, unless its design does not permit, and then ensure such means are tagged to indicate the employees are at work.

- (3) Automatically and Remotely Controlled Switches: The employee in charge shall ensure that automatically and remotely controlled switches that could cause the opened disconnecting means to close are also tagged at the points of control. The employee in charge shall render the automatic or remote-control feature inoperable, unless its design does not so permit.
 - (4) Tags: Tags shall prohibit operation of the disconnecting means and shall indicate employees are at work.
 - (5) Test for energized condition: After the applicable requirements of this section have been followed and the system operator gives a clearance to the employee in charge, the person in charge shall ensure the lines and equipment are deenergized by testing the line with an approved voltage rated testing device.
 - (6) Install Grounds: The person in charge shall ensure the installation of protective grounds.
- (d) Transfer Clearance: To transfer a clearance, the employee in charge (or the employee's supervisor if the employee in charge must leave the worksite due to illness or other emergency) shall inform the system operator and employees on the crew; and the new employee in charge shall be responsible for the clearance.
 - (e) Releasing Clearance: To release a clearance, the employee in charge shall:
 - (1) Notify each employee under the clearance of the pending release of clearance.
 - (2) Ensure all employees under the clearance are clear of the lines and equipment.
 - (3) Ensure all protective grounds protecting employees under the clearance have been removed.
 - (4) Report this information to the system operator and then release the clearance.
 - (f) Person Releasing Clearance: Only the person in charge who requested the clearance can release the clearance, unless the employer transfers responsibility.
 - (g) Removal of Tags: No one shall remove tags without the release of the associated clearance.
 - (h) Reenergizing Lines and Equipment: The person in charge shall ensure no one initiates action to reenergize the lines or equipment at a point of disconnection until all protective grounds have been removed, all the crews working on the lines or equipment, and all protective tags are removed from the point of disconnection.
 - (i) Employees may not work on lines or equipment as deenergized unless the lines or equipment have been properly grounded and an equipotential zone has been established.

Back-feed- Where the possibility of a back-feed exists, the transformer secondary leads shall be disconnected from the transformer and all secondary leads shall be grounded or shunted.

Equal Potential Zone

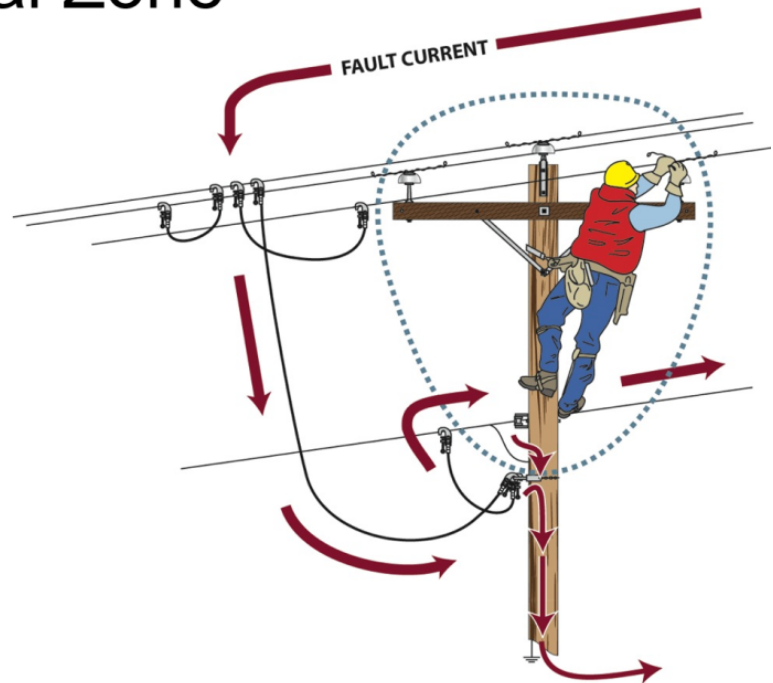

Equal Potential Zone (Equipotential)

Temporary protective grounds and bonds shall be placed at such a location and arranged in such a manner that the person in charge can demonstrate that it will prevent each employee from being exposed to hazardous differences in electrical potential.

Protective Grounding Equipment:

- (1) Conductor(s) or equipment to be grounded shall be clearly identified and isolated from all sources of voltage.
- (2) The installation of grounding devices and bonds shall be performed with live-line tools
- (3) Protective grounding equipment shall be capable of conducting the maximum anticipated fault current
- (4) Grounding devices shall have a minimum conductance of Number 2 AWG
- (5) Protective grounds shall have an impedance low enough, so they do not delay the operation of protective devices in case of accidental energizing of the lines or equipment
- (6) There shall be a minimum of one ground on the conductors or equipment being worked on:
 - a. Between the place where the work is being done and each possible source of supply,
 - b. at the work location or,
 - c. as close as practicable to the source of supplyNote: In all cases an Equipotential Zone must be established.

- (7) One of the grounding devices shall be visible to at least one member of the crew unless one of the grounding devices is accessible only to authorized persons
 - a. Any exposed de-energized part of a line normally operated at a voltage in excess of 600 volts, phase to phase, shall not be worked on until the normally energized parts have been proven to be de-energized and all conductors of the circuit have been short-circuited and grounded against all possible sources of energy. Energized high-voltage lines, which cross over or under a de-energized line, shall be considered possible sources of energy.
 - b. Portable grounding devices shall be secured to permanently grounded objects at the location selected for grounding in the following order of preference:
 - i. Substation ground grid
 - ii. 4-Wire multi grounded primary neutral
 - iii. Grounded steel structure
 - iv. A temporary ground rod/screw ground installed to a minimum depth of 4 feet

2.08 Use of Rubber Protective Equipment

Electrical protective equipment shall be maintained in a safe, reliable condition. The following specific requirements apply to insulating blankets, covers, line hose, gloves, and sleeves made of rubber:

- (a) Insulating equipment shall be inspected for damage before each day's use and immediately following any incident that can reasonably be suspected of having caused damage. Insulating gloves shall be given an air and water test at the beginning of each work period or as needed, along with the visual inspection.
 - (1) Check for laboratory test date and issue date. (refer to section 2.21 (a) (3))
 - (2) Blankets shall be inspected stretched and rolled to check for damage or weather checking
 - (3) Line Hose and hoods shall be turned inside out and visually examined for cuts and/or other defects.
 - (4) At no time shall any rubber goods or protective equipment be used with any kind of patches on them.
- (b) Insulating equipment with any of the following defects may not be used:
 - (1) Holes, tears, punctures, or cuts.
 - (2) Ozone cutting or ozone checking (the cutting action produced by ozone on rubber under mechanical stress into a series of interlacing cracks).
 - (3) An embedded foreign object.
 - (4) Any of the following texture changes: swelling, softening, hardening, or becoming sticky or inelastic.
 - (5) Any other defect that damages the insulating properties.
- (c) Insulating equipment found to have other defects that might affect its insulating properties shall be removed from service and returned for testing.

- (d) Insulating equipment shall be cleaned as needed to remove foreign substances.
- (e) Insulating equipment shall be stored in such a location and in such a manner as to protect it from light, temperature extremes, excessive humidity, ozone, and other injurious substances and conditions. (i.e. sharp object or other abrasive materials).
 - (1) Rubber gloves and sleeves shall be stored in an approved glove bag.
 - (2) Blankets shall be rolled and not folded when being stored.
- (f) Rubber Glove protectors shall be worn over all insulating gloves

2.09 Climbing Equipment

- (a) Climbers shall not be used after the gaffs are worn or filed to less than 1 ¼ inches long, measured on the underside of the gaff.
- (b) Climbers shall be worn only when engaged in work requiring their use and shall never be worn when: driving or riding in a vehicle; setting, removing or handling poles; working on the ground; or while working on floors or roofs.

INSTRUCTIONS FOR SHARPENING GAFFS (SPURS) ON CLIMBERS

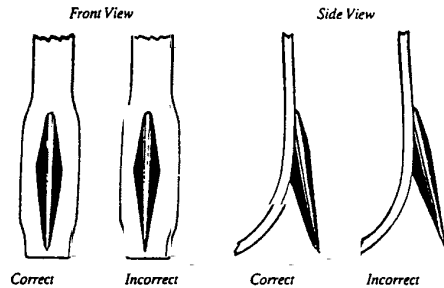

1. Always use sharp file. NEVER grind to a point on any kind of wheel as you are likely to set up heat which will spoil the temper of the gaff and make it dangerous to use.
2. Set climber in a vise with the gaff uppermost and the stirrup of the climber turned down so that you can file from heel to point of gaff. File toward the point and down to the edges of the underside of the gaff. Remove only sufficient material to make a good point.
3. Do not make a needle point. File both side slopes, but not the top of gaff, to even rounded edges, so that the final point is always in the top ridge of the gaff.
4. The underside of the gaff should be left perfectly straight to within 1/16" of the point, then rounded slightly toward the top ridge of the gaff on a radius of 1/4". At a distance 1/16" back from the point, you should have a width of approximately 1/32" measured on the underside of the gaff. The remainder of the underside should be kept perfectly straight.
5. For safety, climbers should not be used after the gaffs are worn or filed to 1 ¼" long, measured on the underside of the gaff. When climbers get in this condition, they should be regaffed or a new pair obtained. By following these simple instructions, a satisfactory job can be secured and no unnecessary risks will be taken.

2.10 Working in Elevated Positions

- (a) Before climbing poles or structures, or approaching the overhead work area, employees shall familiarize themselves with the circuits and apparatus thereon and any unusual conditions which might present a hazard.
- (b) Fall Protection: When work is performed at elevated locations more than 4 feet (1.2 meters) above the ground on poles, towers, or similar structures the employer shall require the employees to use either fall arrest equipment, work positioning equipment, or travel restricting equipment if other fall protection methods have not been provided (e.g. guardrails, safety nets, etc.) . The use of body belts for fall arrest systems is prohibited.
 - (1) Employees in aerial lift equipment shall be secured to the lift equipment when in an elevated position by a lanyard attached to a full-body harness.
 - (2) Employees working from Ladders and Horizontal Platforms; Anchorages used for attachment of personal fall arrest equipment shall be independent of any anchorage being used to support or suspend platforms and capable of supporting at least 5,000 pounds per employee attached, or shall be designed, installed, and used as follows:
 - i. As part of a complete personal fall arrest system which maintains a safety factor of at least two; and (B) under the supervision of a qualified person
 - ii. Independent Anchorages must be attached directly to the Structure.
 - (3) Safety belts/body belts are prohibited for use in personal fall arrest systems but may be used as part of a fall restraint or positioning device system.
 - (4) Safety belts/body belts used as part of a positioning device system shall be rigged such that an employee cannot free fall more than 2 feet. Transfer lanyard shall not be used as a primary working belt.
 - (5) A body harness may be used in a personal fall restraint positioning or fall arrest system. When a body harness is used in a fall arrest system, the lanyard shall be rigged with a deceleration device to limit maximum arresting force on an employee to 1,800 pounds and prevent the employee from hitting any levels or objects below the basked to platform and shall limit free fall to a maximum of 6 feet.
- (c) Each qualified employee climbing or changing location on poles, towers, or similar structures must use 100% fall protection equipment unless the employer can demonstrate that climbing or changing location with fall protection is infeasible or creates a greater hazard than climbing or changing location without it.
- (d) Not more than one employee shall ascend or descend a pole at the same time. The first employee shall be in place on the pole or on the ground before the next employee ascends or descends the pole. When it becomes necessary for one employee to work above the other, they shall exercise extreme care.
- (e) Before climbing poles, ladders, scaffolds, or other elevated structures, or riding span wires, messengers or cables, or entering cable cars, boatswains' chairs or similar equipment, the employee shall first ensure that said structure or device is strong enough to safely sustain their weight.
- (f) Employees shall observe the pole brand to assist in evaluating that the pole is set to proper depth.
- (g) The personal use of cell phones while working in elevated positions is prohibited.

(h) Aerial Rescue

- (1) Description: Aerial Rescue is used whenever a person is incapacitated while in an elevated position. The purpose in rescuing a person is to clear the victim from any imminent danger, administer first aid, and lower the victim to the ground as quickly as possible. NOTE: As with all rescue operations, the safety of the rescuer(s) shall be taken into consideration before a rescue is attempted.
- (2) Training: The employer shall establish rescue procedures and provide training in emergency response. Training in aerial rescue procedures shall be provided for employees whose job assignments may require them to perform aerial rescues.
- (3) Rescue Breathing: In the event it becomes impossible to lower a victim immediately or within a reasonable amount of time (three to four minutes), rescue breathing should be started at once.
- (4) Rescue Equipment: Lines used for emergency rescue such as lowering a person to the ground shall have a minimum breaking strength of 2,650 pounds and shall be readily available on the jobsite.

2.11 Belts and Safety Straps and Harnesses

- (a) Only approved safety straps, body belts and full body harnesses per manufacturer's recommendation shall be used.
- (b) Fall Protection Equipment shall be inspected before use each day to determine that the equipment is in safe working condition. Fall Protection Equipment that is not in safe working condition may not be used.
- (c) Employees shall not work on an erected pole, tower or other elevated structure, including truck-mounted ladders and mechanical or hydraulic platform lifts, without first securing themselves with an approved safety strap or life line attached to an anchorage point mounted on the structure or equipment.
- (d) Employees working in aerial lifts SHALL SECURE THEMSELVES to the attachments provided.
- (e) Employees shall look to make sure that the snap hook and "D" ring are properly engaged before the weight of the body is placed on the safety strap. Employees shall never rely on the "click" of the keeper in the snap as an indication that the fastening is secure.
- (f) When a safety strap is in use, both snap hooks shall not be attached to the same "D" ring.
- (g) Wire hooks shall not be attached to body belts.

2.12 Hand Lines

- (a) An approved hand line shall be placed on every structure or aerial work platform where line work is being performed on energized primary conductors or apparatus.
- (b) An approved line with a minimum breaking strength of 2650 lbs. may be used when lowering a person from a pole or elevated position, provided the rope is passed over a cross-arm or fixed member of the structure and is not directly supported by the hand line sheave. Sheaves designed for rescue are permitted.
- (c) When raising or lowering tools or lightweight material, a hand line, or hand line with material bag attached thereto, shall be used.

2.13 Testing Poles and Stubs

All poles shall be tested prior to climbing and the tests shall be made as follows:

- (a) Make a close visual inspection and a hammer test for any physical defect, which might weaken it.
- (b) Expose to at least 12 inches below ground on one side of the pole and inspect for defects as noted in (a) above. If set in pavement, test by boring as outlined in sub-paragraph (c) below, except start the drill hole as close to the pavement as possible.

NOTE: If it is evident that the pole is defective after either of steps (a) or (b), further testing is not necessary, and the pole shall be adequately supported before climbing.

- (c) Poles: Bore a 9/16-inch hole at the center line of the pole at the bottom of the excavation at a 30 to 40-degree angle with the surface of the pole, to within about 2 inches of the opposite side, taking care not to break through. If the soundness of the pole is questionable after the first boring, bore a second hole at right angles to the first at ground level. If the soundness of the pole is questionable at this point, it shall be adequately supported before climbing. The drill holes shall be plugged with a 5/8-inch approved plug.
- (d) Stubs: Wood and steel stubs used to reinforce wood poles at the ground line shall be treated as part of the pole and tested as determined necessary. The testing shall be performed as follows:
 - (1) The metal stubbing bands for both wood and steel stubs shall be inspected, and the pole shall be checked for soundness above and below each band. The bands must be in good condition and shall be tight.
 - (2) Wood stubs shall be considered as part of the pole and tested as outlined in Rule 2.13 (a) through (c).
 - (3) Galvanized steel stubs shall be checked for soundness by visual inspection at the ground line for rust or corrosion. If rust is detected, the stub shall be exposed a minimum of 12 inches to determine the extent of corrosion. If corrosion has not penetrated more than the surface metal and extends less than 1/3 the perimeter of the stub, it shall be sounded with a hammer, if found solid, be considered of adequate strength to support the pole. If corrosion has penetrated the surface and extends the full perimeter of the stub, or it is not possible to determine the extent of corrosion, the pole shall be adequately supported before climbing.

2.14 Blasting Pole Holes

- (a) All blasting of holes for power lines shall be done by Qualified and authorized employees.
- (b) The employee in charge shall instruct all persons to keep "in the clear" before and during blasting operations.
- (c) Three distinct audible warnings shall be given before blasting.
- (d) Lead wires and firing lines shall be short-circuited up to the time they are connected to the firing mechanism.
- (e) All loaded holes shall be properly tamped with earth, using a wooden rod.
- (f) Blasting under power lines, or where damage to property is a possibility, shall not be done without approval

from at least a second-level Supervisor, and then only as follows:

- (1) When it is impractical to dig otherwise.
 - (2) Collars shall be dug as far as practicable and holes shall be covered with a mat or equivalent which shall be securely tied down or weighted down to prevent materials being blown into line.
 - (3) Lead wires shall not be run parallel to the power line and shall be securely anchored.
- (g) Electric blasting caps and explosives shall be transported in accordance with applicable Governmental Codes or Regulations.
- (h) No electric blasting shall be performed within 100 feet of a transmitting radio. For minimum safe distance from radio stations, see applicable Governmental Safety Regulations.

2.15 Setting or Removing Poles

- (a) All persons not engaged in pole setting operations shall be kept out of the work area.
- (b) No one shall be allowed on a gin pole when it is being used to raise another pole.
- (c) When setting or removing poles between or near exposed energized conductors where danger of contact with conductors or equipment may exist:
- (1)
 - i. Ground wires, guy wires or metallic hardware running the length of the pole shall not be attached to the pole.
 - ii. The conductors shall be spread to minimize accidental contact or covered with approved protective devices or the pole shall be covered with an approved guard or the conductors shall be de-energized.
 - (2) All personnel who may handle the butt of the pole shall wear approved rubber gloves and sleeves rated for the nominal voltage of the line whether or not cant hooks or slings are used.
- (d) No one shall step on or off the truck or vehicle or touch any part of the truck or associated equipment from the ground, while the pole is being set, or until it is secured in such a manner that it could not possibly come in contact with energized conductors or apparatus.
- (e) Guy ropes may be used to control the pole.

2.16 Common Neutral Systems

- (a) The common neutral conductor shall not be opened at any point except by first installing an approved temporary jumper around the proposed open point.

Note: A Common, Return, or Primary Neutral may not be clearly identified as such, therefore a thorough visual inspection of the conductors shall be completed prior to the placement of temporary jumpers or the opening of any such conductor.

- (b) Common neutrals at the secondary level shall be worked on as conductors or apparatus energized at less than 250 volts, phase to ground, in accordance with Rule 2.03.
- (c) The vertical run connecting the common neutral at the primary level shall be considered as secondary and

worked in accordance with Rule 2.03 except that portion located at less than minimum approach distance from exposed energized parts, in which case it shall be considered as primary and worked as such. In all cases primary neutral line conductors and jumper wires shall be considered and worked as primary.

2.17 Wire Stringing

- (a) When stringing or taking down wires, the number of persons actually handling the wire at any one time shall be held to a minimum. Running lines, hold down lines, and tag lines shall be used and left attached until the wires are in place and properly secured.
- (b) When stringing or taking down wire, the equipment pulling the wires shall be adequately barricaded. Other precautionary measures, such as flagmen and cradles shall be used as required.
- (c) When stringing or taking down wires on poles or towers on which there are energized lines, precautions shall be taken to create an equipotential zone, insulate, or isolate the employees from the wire or wire stringing equipment. In addition to the above requirements, bare wires (except bare neutrals in multi-conductor cables) shall be pulled over grounded rollers at the first pole or second pole from the payout and take-up equipment. The metal frame of the wire stringing equipment shall be bonded to the traveling ground. When stringing parallel to lines energized in excess of 35kV the conductor being installed or removed shall be pulled over grounded rollers at the first structure adjacent to both the tensioning and pulling set-up.
- (d) When stringing or taking down wires crossing over energized lines, suitable protection or guards shall be installed at the point of crossing as necessary.
- (e) Reliable communications shall be maintained at all times while stringing wire. If communication is lost between the puller and the tensioner operators, the puller operator shall bring the pull to a gradual stop, and shall not start the pull until communications are restored.

2.18 Capacitors

- (a) Before any work is done on switched or fixed capacitor installations, the circuit breakers and/or fuse cutouts shall be opened, using load break devices where applicable. After waiting five minutes, using live-line tools the capacitor terminals shall be shorted by means of approved temporary jumpers. The shorted terminals shall also be securely bonded to the capacitor cases. Whenever practical, the short circuit and bond shall be left on until all work is completed. If the primary taps from the cutouts or circuit breakers to the line conductors are not removed grounds shall be placed on the leads from the cutouts or circuit breakers to the capacitor terminals.
- (b) On all primary voltages live line tools, or other approved devices, shall be used while installing or removing temporary jumpers.

2.19 Apparatus Leads

When working on de-energized apparatus normally energized above 7,500 volts, phase to phase, the conductors between the open switch or fuse holders and the apparatus shall be grounded. When it is impracticable to ground as above, the taps shall be removed from the line with live line tools.

2.20 Banked Secondaries

Where secondary leads of transformers are banked or there is a possibility of a back-feed, the transformer leads shall be disconnected in addition to removing primary fuses or disconnecting the primary leads from the line before any work is done on the transformer. Before any work is done where transformers are

banked or there is a possibility of back-feed:

- (1) The primary fuses and/or primary leads must be removed and
- (2) The secondary leads must be removed.

2.21 Rubber Gloving to 21kV

(a) Equipment

- (1) Class 2 rubber gloves, with protectors at a minimum, shall be worn on voltages up to 17kV phase to phase. Class 3 rubber gloves at a minimum shall be worn while working on energized conductors from 17kV up to 21kV phase to phase.
- (2) It shall be mandatory that sleeves of the same voltage rating as the rubber gloves, or higher, shall be worn when working on energized conductors or apparatus above 7,500 volts phase to phase.
- (3) The dielectric testing of insulating equipment shall be performed following “ASTM standards on electrical equipment for workers”.
 - i. Gloves and sleeves shall be marked with the test date.
 - ii. Gloves and sleeves will be changed out on a 90-day cycle from the date they are issued.
 - iii. Blankets will be changed out on a 180-day cycle from the date they are issued.
 - iv. The shelf life of these items shall not exceed 6 months from the last test date. Rubber goods may be issued up to 6 months after the test date, the change-out cycle begins after issue.
 - v. Any items the employee feels need to be changed out will be done without question, even if it's before the due date.
 - vi. Rubber Gloves and sleeves that have been issued once will not be re-issued to another employee until they have been re-tested.
- (4) Gloves, sleeves and blankets shall not be folded while in storage; however, blankets shall be permitted to be rolled for storage. All rubber goods, when not in use shall be kept in approved glove bags or other approved containers and stored where they will not become damaged from petroleum products, sharp objects, direct sunlight, steam pipes, radiators and other sources of excess heat.
- (5) Rubber gloves shall never be worn inside out or without approved glove protectors. Protectors shall be used only in conjunction with rubber gloves and shall not be worn for work gloves. Rubber gloves shall be ***air and water*** tested at the beginning of each work period or as needed. All insulating equipment shall be visually inspected for defects and cleaned prior to use each day. It must be noted that cuffs are generally susceptible to the most damage and must be stretched to detect abrasions and weak spots.

No. 1 – Examine entire outer surface for Burns, Cuts, Cracks, Puncture and Weak Spots



No. 2 – By stretching cuff slightly, abrasions and weak spots will be more evident

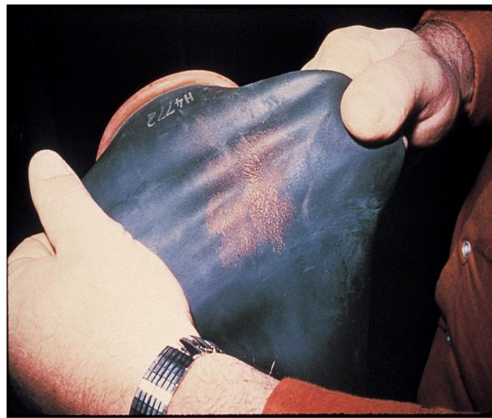

No. 3 – Examine inside of the cuff for tears, punctures, etc.

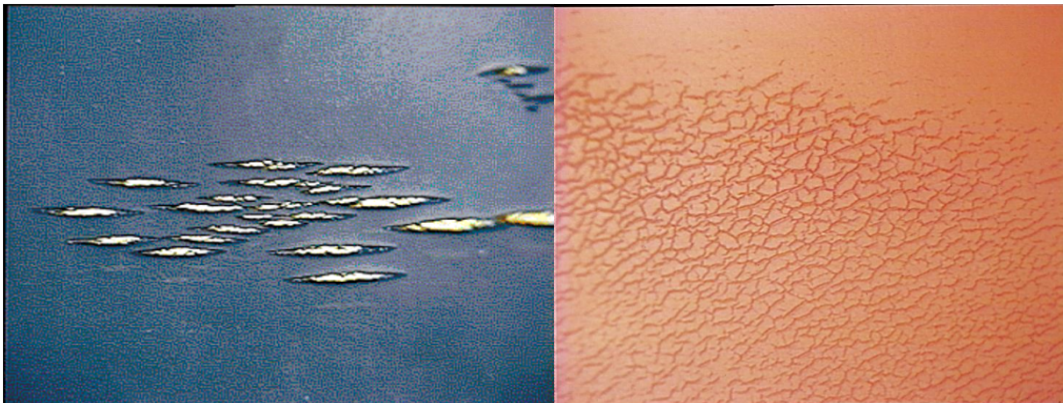

- (6) No patches will be allowed on any insulating equipment. If a piece of insulation is found to be defective it will be removed from the job immediately.
- (7) Bucket trucks and boom trucks used in rubber gloving procedures shall require an annual dielectric test after every major or periodic inspection, using the manufactures and the ANSI/SIA A92.2-(2001) 5.4.2.4 (lower boom) and 5.4.3.1 (upper boom) category A&B testing requirements. This requirement shall not supersede any additional manufacturer requirements. A sticker or label shall be prominently displayed on each piece of tested equipment indicating the last test date.
- (8) All elbow type bucket trucks used in rubber gloving procedures shall have both insulated upper and lower booms. Both insulated booms shall be tested.
- (9) Aerial lifts/digger derricks used for rubber gloving high voltage conductors and equipment energized over 7,500 volts shall have both upper and lower horizontal and vertical positioning controls. Both sets of controls shall be operational when high voltage work is being done.
- (10) All buckets trucks used in rubber gloving procedures will be equipped with bucket liners with a liner bottom protector installed. The bucket liners will be tested on an annual basis following the ANSI A92.2 (2001) paragraph 5.4.3.5 or 5.4.2.5 standards.
- (11) All operators of aerial devices shall be trained to operate such equipment as per ANSI/SIA A9.2.2 (2001) 8.12. If they have not operated the equipment for a period of 12 months, they will be required to be re-trained.
- (12) When using fiber strap hoists, an approved insulated link stick shall be installed between the hoists and any other surface with a different potential. Fiber strap hoists shall be kept clean, dry and in good repair.
- (13) Energized conductors shall be insulated from winch or other lines by the use of an insulated link stick or approved rubber insulating equipment.
- (14) Jumpers with or without pickup heads shall be considered un-insulated. If the jumper cable cannot be isolated so there is not a possibility of contact with personnel, other conductors, poles, cross arms or hardware, the jumper cable shall be covered with line hose or blankets in the same manner as other conductors would normally be covered.

(b) Work Procedures for Rubber Gloving

(1) **Before any work is to be done**

- i. A complete tailboard shall be held per Section 1.37. The purpose is to ensure all personnel are aware of the work and associated hazards.
- ii. All rigging shall be inspected and assured to be in good working order and appropriate for the work being performed.
- iii. All rubber goods and high voltage protective equipment shall be inspected to verify safe condition. The inspection shall include verifying test and issue dates.
- iv. Immediately prior to using aerial devices for high voltage rubber glove work all insulated portions shall be visually inspected and wiped clean.
- v. All energized conductors or equipment within reach of minimum approach distance (MAD) shall be covered with approved protective equipment or floated free from the pole except

those parts that are actually being worked on.

- vi. When work is performed on energized primary conductors, all second points of contact (for example other conductors, neutral grounds, cross-arms, poles, pot-heads etc.) within reaching distance shall be covered with approved protective equipment.
- vii. Where possible and upon request of the crew, the automatic re-closer shall be made non-automatic.
- viii. When an energized primary conductor is placed on the cross-arm or against the pole, it shall be covered with a line hose; in addition, the cross-arm or pole shall be covered with approved protective devices.
- ix. When work is being performed on high voltage energized conductors, on the same structure, the work shall be confined to only one phase of a circuit at a time.
- x. Separate structures and conductors may be worked simultaneously provided the job is coordinated so all personnel are safeguarded from unexpected changes in work distances due to movement of conductors or equipment. At all times personnel shall be under direct supervision of the Foreman.
- xi. Pedestrians will be diverted around the work area.
- xii. Rubber gloving shall not be performed whenever the majority of Journeyman Lineman determine that it would be unsafe to do so.
- xiii. If inclement weather develops after work has begun and the job must be completed, the live line tool method shall be used, or the circuit shall be de-energized.
- xiv. Any work that may produce an arc will require the use of live-line tools. Such work shall include opening switches; installing or removing energized jumpers under load, grounding, etc.
- xv. Live-line tools and attachments shall be maintained on the crews.
- xvi. No conductive tools, equipment or material shall be allowed to hang on the outside of the buckets. Caution should be used to ensure the manufactures weight capacities of the aerial lift are not compromised.
- xvii. Electric cords shall not be allowed in the primary zone.

(2) Gloving from Insulated Buckets:

- i. All crew members shall be trained in bucket truck rescue techniques and familiar with the lower controls.
- ii. During rubber gloving procedures, the bucket trucks will be barricaded with cones, caution tape, or similar devices. All ground personnel will be instructed in the hazards of contacting the bucket truck if the truck should become energized.
- iii. Personnel shall safety-off to the special attachments provided for that purpose and shall keep their feet on the floor at all times.

(3) Gloving from Structures:

- i. Gloving on energized conductors above 7,500 volts phase to phase from wooden poles or grounded structures shall not be permitted unless working from an approved insulated platform. When an approved insulated platform is used, it shall be visually inspected and clean prior to use and each employee must be separately attached back to the pole with an insulated anchorage point to insulate the worker from ground potential at the structure. The insulating anchor provides a 5000-pound structure-based anchorage for each worker's Fall Protection equipment. The pole will be insulated when the work to be accomplished is within reaching distance of the pole.
- ii. Conductive equipment or material shall not be passed between a pole or structure and an approved insulated platform while an employee working from the platform is within reaching distance of energized high voltage conductors or equipment that are not covered with insulating protective equipment.

(4) Combination Rubber Glove/Live Line Tool Methods

- i. If Live-line tools are to be used in conjunction with Rubber Glove techniques, the tailboard briefing shall clearly establish how the work will be conducted so that safety at the work site will not be compromised.

The Live-Line tools in conjunction with Rubber Glove procedures is to be limited to situations where the safety is not decreased by the introduction of Live Line Tools into the Rubber Glove environment

The following are minimum combinations allowed when working aloft.

1. Two qualified employees in an insulated bucket or on insulated platform(s).
2. One qualified employee in an insulated bucket and one qualified employee on an insulated platform.
3. One qualified employee on an insulated bucket using Rubber Gloves and one qualified employee on the pole utilizing Live Line tools.

The following combination is prohibited:

1. One qualified employee on the pole utilizing Live Line Tools and one qualified on an insulated platform utilizing Rubber Gloves.

(c) PPE and Clothing

(1) When working on or near energized conductors or equipment:

- i. Employees exposed to the hazards of flames or electrical arcs shall wear approved flame resistant (FR) long sleeve shirts (sleeves rolled down and/or buttoned) or other FR clothing as required. Synthetic clothing (For example: acetate, nylon, polyester and rayon) other than FR designated clothing, will not be used under any circumstances. All undergarments worn will be made of natural fibers.
- ii. Hard Hats that meet the ANSI Z89.1 (Class E) dielectric standard will be worn. No metallic buttons, stickers or other devices will be worn on hard hats at any time.
- iii. No metallic objects will be worn any time the worker is in the primary zone. All rings, watches, necklaces, or other jewelry will be removed before entering the primary zone.

- iv. Approved ANSI Z87.1 safety glasses shall be worn continuously during all work operations.

Section 3.0 - Use, Maintenance and Care of Live Line Tools

3.01 Use

- (a) All conductors or apparatus energized above 21,000 volts, nominal phase-to-phase voltage, shall be handled only with live line tools.
- (b) When working on energized conductors or apparatus with live line tools, two Journeymen Lineman, or one Journeyman Lineman and a hot apprentice (working under continuous supervision and instruction of a Journeyman Lineman) shall be assigned to do the work.
- (c) Planned work with live line tools shall not be started during inclement and/or unfavorable weather.
- (d) Only approved live line tools shall be used.
- (e) A careful check shall be made to see that the condition of the structure and lines at the point of the work is such that the job may be performed safely. In addition, the adjacent spans and structures shall be carefully checked for defects in conductors, tie wires, insulators, and other equipment.
- (f) Under no circumstance shall an employee depend on another employee to hold a line conductor clear of him.
- (g) Positive control shall be maintained during the movement of any conductor.
- (h) While live line work is in progress, no other work of any nature shall be performed on the same pole or structure.
- (i) A live-line tools shall be the correct length and strong enough to take the strain.

3.02 Care and Maintenance

- (a) All live line tools, when not in use, shall be kept in live-line tool bags or weatherproof boxes provided for that purpose; these containers shall be stored in a dry and, if possible, warm place.
- (b) Live line tools and plastic cover shall never be laid directly on the ground or against sharp objects. Special tool holders or tarpaulins shall be used for this purpose.
- (c) All live line tools and protective insulating equipment shall be wiped clean and visually inspected before use each day. If any hazardous defects are found this equipment shall be removed from service.
- (d) Guard against scratching or otherwise marring the surface of the live-line tool. Live-line tool fittings that are bent or dented must be replaced.

Section 4.0 - Metal Tower Construction

4.01 Assembling and Erecting

- (a) All excavations shall be performed in accordance with the provisions of Construction Safety Orders.
 - (1) A designated employee shall be used in directing mobile equipment adjacent to footing excavations.
 - (2) No one shall be permitted to remain in the footing excavation while equipment is being spotted for placement.
- (b) Guy lines shall be used as necessary to maintain sections or parts of sections in position, and to reduce the possibility of tipping.
- (c) Members and sections being assembled shall be adequately supported.
- (d) When assembling and erecting towers, the provisions of subsections (1), (2) and (3) of this paragraph shall be complied with.
 - (1) The construction of transmission towers and the erecting of poles, hoisting machinery, site preparation machinery, and other types of construction machinery shall conform to the applicable requirements of this article.
 - (2) No one shall be permitted under a tower that is in the process of erection or assembly, except as may be required to guide and secure the section being set.
 - (3) When erecting towers using hoisting equipment adjacent to energized transmission lines, the minimum clearance distances are required as per State law.
- (e) Erection cranes shall be set on a firm foundation and when the cranes are so equipped, outriggers shall be used.
- (f) Tag lines shall be utilized to maintain control of tower sections being raised and positioned, unless the employer can demonstrate that the use of tag lines would create a greater hazard to employees.
- (g) The load-line shall not be detached from a tower section until the section is adequately secured.
- (h) Except during emergency restoration procedures, erection shall be discontinued in the event of high wind or other adverse weather conditions that would make the work hazardous.
- (i) Equipment and rigging shall be regularly inspected and shall be maintained in a safe operating condition.
- (j) Traffic control shall be provided where applicable.

4.02 Stringing, Removing, and Handling Conductors

- (a) Precautions shall be taken to protect all employees from any accidental contact between the conductors being installed or removed from any energized conductors.
- (b) Strains to which poles or structures will be subjected to shall be taken into consideration and necessary action taken to prevent failure of supporting structures.

- (c) A briefing shall be held setting forth the plan of operation, the type of equipment to be used, grounding devices and procedures to be followed, crossover methods to be employed and the clearance authorization required.
- (d) Employees shall be protected from hazardous differences of potential. When there is a possibility of the conductor accidentally contacting any energized high voltage circuit or receiving a hazardous induced voltage, the conductor being installed, removed, or handled shall be grounded and an equipotential zone created, or provisions made to isolate or insulate the employee(s).
 - (1) If an existing high voltage line being crossed is de-energized, proper clearance authorization shall be secured and the line grounded at or on both sides of the crossover or the conductors being crossed shall be considered energized.
 - (2) When crossing over or within 10 feet under conductors energized in excess of 300 volts, rope nets or guard structures shall be installed unless provision is made to isolate or insulate the workmen or the energized conductor. Where practical, the automatic re-closing feature of the circuit interrupting device shall be made inoperative. In addition, the line being strung shall be grounded on either side of the crossing or considered and worked as energized.
- (e) Conductors shall be kept under control by the use of tension reels, guard structures, taglines or other means to prevent contact with energized circuits.
- (f) Guard structures shall be of adequate dimension and strength to safely support anticipated loads.
- (g) Reel handling equipment, including pulling and braking machines, shall have ample capacity, operate smoothly, and be leveled and aligned in accordance with the manufacturer's operating instruction.
- (h) Suitable communications between the reel tender and pulling rig operator shall be provided.
- (i) Each pull shall be snubbed or dead-ended at both ends before subsequent pulls are made.
- (j) Employees shall operate the pulling rig only when safe to do so.
- (k) Adjacent to Energized High Voltage Lines.
 - (1) Prior to stringing, removing, or handling conductors adjacent to an existing energized overhead high voltage line, a determination shall be made to ascertain whether hazardous induced voltage buildups will occur. When it has been determined that such hazardous induced voltages may exist, the person in charge shall ensure compliance and all employees shall comply with the following provisions (i. through viii.) unless the line is worked as energized.
 - i. The tension stringing method or other methods that preclude unintentional contact between the lines being pulled and any employee shall be used.
 - ii. All pulling and tensioning equipment shall be grounded or shall be considered as energized and shall be barricaded, isolated or insulated.
 - iii. Temporary protective grounds shall be placed at such locations and arranged in such a manner that the person in charge can demonstrate will prevent exposure of each employee to hazardous differences in electrical potential.
 - 1. The grounds shall be left in place until conductor installation is completed.
 - 2. Such grounds shall be removed as the last phase of aerial clean-up.
 - 3. Except for traveling type grounds, the grounds shall be placed and removed

by the use of non-conductive means.

- iv. A ground shall be installed between the tensioning reel set-up and the first structure in order to ground each bare conductor, sub-conductor, and overhead ground conductor during stringing operations.
- v. Conductors, sub-conductors, and overhead ground conductors shall be grounded at all dead-end or catch-off points.
- vi. A ground shall be located at each side and within 10 feet of working areas where conductors, sub-conductors, or overhead ground conductors are being spliced at ground level. The two ends to be spliced shall be bonded to each other.
- vii. The conductors, sub-conductors, and overhead ground conductors being worked on shall be bonded to the tower at every work location.
- viii. Employees standing on the ground shall not be permitted to contact equipment or machinery working near energized lines or equipment unless the employee is using suitable protective equipment for the voltage involved.

4.03 Rigging

- (a) The rated capacity of catch-off anchors, rigging, and hoists shall not be exceeded.
- (b) The design load rating shall not be exceeded for the stringing lines, pulling lines, sock connections, and all load-bearing hardware and accessories.
- (c) Pulling lines and accessories shall be inspected regularly and replaced or repaired when damaged.

4.04 Grips

Grips shall only be used for the purpose for which they are designed.

4.05 Pulling Line

While the conductor or pulling line is in motion:

- (a) Employees on wood poles shall not be permitted to be on the cross-arm.
- (b) Employees on steel structures shall not be permitted to be on the cross-arm except as necessary to install the conductor or pulling line into the stringing sheaves.
- (c) Employees on the ground shall not be permitted directly under the conductor or pulling line in motion except as necessary for the employees to guide the stringing sock or board over or through the stringing sheave.

4.06 Clipping

A transmission clipping crew shall have a minimum of two structures "clipped-in" between the crew and the conductor being sagged in the adjacent pull. Refer to Section 2.07.

Section 5.0 - Entering and Working in Underground Structures

DEFINITIONS:

Enclosed Space:

A working space, such as a manhole, vault, tunnel, or shaft that has a limited means of egress or entry, that is designed for periodic employee entry under normal operating conditions and that, under normal conditions, does not contain a hazardous atmosphere, but may contain a hazard under abnormal conditions.

Confined Space:

- (1) Is large enough and so configured that an employee can bodily enter it;
- (2) Has limited or restricted means for entry and exit; and
- (3) Is not designed for continuous employee occupancy

Safe Work Practices:

Written, understandable safe work practices for entry into, and work in enclosed spaces and for rescue procedures shall be developed, implemented, and provided to affected employees.

5.01 Qualified persons

Only qualified persons shall be assigned to work on energized underground conductors or equipment. Persons in training who are qualified by experience and training shall be permitted to work on energized underground conductors or equipment while under the continuous supervision or instruction of a Journeyman Lineman/Cable Splicer and/or Substation Technician.

5.02 Safeguards

- (a) Attendants. While work is being performed in the enclosed space, an attendant with first-aid and CPR training shall be immediately available outside the enclosed space to provide assistance if a hazard exists because of traffic patterns in the area of the opening used for entry. The attendant is not precluded from performing other duties outside the enclosed space if these duties do not distract the attendant from monitoring employees within the space or ensuring that it is safe for employees to enter and exit the space.
- (b) Training. Employees, including attendants, shall be trained in the nature of the hazards involved, the necessary precautions to be taken, the use of protective equipment and emergency equipment, the enclosed-space entry procedures, rescue procedures, and safe work practices, including instructions as to the hazards they may encounter.

5.03 Safe Work Practices

- (a) Access, Egress A ladder shall always be used in entering or leaving a manhole or vault. Climbing into or out of manholes or vaults by stepping on cables or hangers is forbidden.
- (b) No employees shall be permitted to enter or remain within any manhole, vault, or similar structures unless the atmosphere has been tested and determined to be safe for entry and remains safe. The manhole or vault shall be tested with an approved tester prior to entering, and with sufficient frequency to ensure that the development of dangerous air contamination, oxygen enrichment and/or oxygen deficiency does not occur during the performance of any operation. The employee shall determine that the instrument is calibrated and in proper working order. A written record of such testing results shall be made and kept at the worksite for the duration of the work.
- (c) If it is not feasible to ensure the removal of dangerous air contamination, oxygen enrichment and/or oxygen

deficiency, this condition is likely a “Permit Required Confined Space”. In such cases employees shall not enter this space and shall contact the company Safety Personnel or other qualified persons designated by the company for assistance.

- (d) Whenever an employee enters a manhole, vault, or similar structure, they shall make an inspection to determine if any hazardous conditions exist. Inspection of a manhole, vault, or similar structure containing cable shall include a heat scan. Appropriate safeguards shall be applied as required prior to the performance of any work.

NOTE: Enclosed space inspection shall follow company and/or customer heat deviation requirements.

- (e) Rescue Equipment: Employers shall provide equipment to ensure the prompt and safe rescue of employees from enclosed space.
- (f) Removing Covers. When covers are removed from enclosed spaces, the opening shall be promptly guarded by a railing, temporary cover, or other barrier designed to prevent an accidental fall through the opening and to protect employees working in the space from objects entering the space. These warning devices shall not be removed until permanent covers are in place.

5.04 Working on Cable or Apparatus

- (a) Accessing Energized Pad-Mounted Equipment and Apparatus:
 - (1) Only Journeyman Lineman and/or Qualified Electrical Workers are permitted to access Pad-Mounted Equipment and Apparatus.
 - (2) The Journeyman Lineman and/or Qualified Electrical Workers shall perform a thorough inspection of the exterior prior to accessing or opening equipment or apparatus.
 - (3) Live-line tools shall be used to install rated insulated cover over cable termination(s), splices or any area where the concentric wires or cable shielding has been removed or exposed energized conductors.
- (b) Every possible precaution shall be exercised to make sure of the correct identity (voltage, circuit, phase, etc.) of the cable or apparatus to be worked upon.
- (c) When employees are working in an underground structure, the automatic circuit reclosure on the circuit being worked shall be made non-automatic.
- (d) When work is performed that requires the connection or separation of shielding on underground cables, or foreign grounds* in the presence of energized primary cables, action shall be taken to eliminate any difference in potential.

*Foreign grounds such as hard-line, fish tapes, duct rollers, etc...
- (e) All switching in manholes, vaults, or similar structures shall be done from outside the structure, if possible.
- (f) A clearance, if required, shall be obtained in the prescribed manner whenever any cable or apparatus is to be de-energized and cleared for work.
- (g) The cable or apparatus shall be considered energized and worked with adequate protective devices (rubber gloves shall not be considered to be suitable devices on voltages in excess of 7,500 volts) until it has been:
 - (1) Tested with an approved device and proven to be de-energized,
 - (2) Grounded from all possible sources of power (including transformers and secondary back-feed),
 - (3) Proved de-energized at the work location.
 - (4) Where cables are not permanently identified by tags or otherwise, diagrams and information establishing

positive identification and position of the cables shall be supplied to the workers.

- (5) When multiple cables are present in a work area, the employee shall identify the cable to be worked on with the use of approved electrical test equipment. The employee shall protect cables other than the one being worked from damage.
- (h) Employees may work in the high-voltage compartment of pad mounted transformers and similar equipment installed above ground and energized in excess of 7500 volts phase to phase, provided the work is done by suitable devices. Rubber gloves shall not be considered to be suitable devices.
- (i) Energized cables over 600 volts shall be moved only under the direction of the employee in charge.

5.05 Moving Cables

- (a) The person in charge shall ensure that employees inspect energized cables to be moved for abnormalities.
- (b) If employees perform work which could cause a fault, the employee shall be protected from possible effects of failure using shields or other devices capable of containing the adverse effect of the fault.
- (c) Cables with abnormalities: Where a cable in a manhole or vault has one or more abnormalities that could lead to a fault or be an indication of an impending fault, the person in charge shall de-energize the cable with the abnormality before any employee may work in the manhole or vault.
- (d) The person in charge shall treat the following abnormalities as indications of impending faults unless the employer can demonstrate that the following conditions could not lead to a fault:
 - (1) Oil or compound leaking from the cable of joints
 - (2) Broken cable sheaths or joint sleeves
 - (3) Hot localized surface temperatures of cables for joints, or
 - (4) Joints swollen beyond normal tolerance

5.06 Static Charge on De-Energized Cables

Before working on any section of cable or apparatus to which cable is connected, care must be exercised to ensure the cable has been grounded to drain off any static charge.

5.07 Grounding Procedures

- (a) Cables and equipment to be grounded shall be clearly identified and isolated from all sources of voltage.
- (b) Notification shall be obtained from the designated employee that all switches or other points of isolation through which electric energy may be supplied to the conductors or equipment to be worked on have been opened and are plainly tagged indicating that personnel are at work, and where the design permits, they have been rendered inoperable.
- (c) A visual inspection and test with an approved instrument will be made to ensure the cables or equipment have been de-energized.
- (d) Guards or barriers will be installed as necessary to prevent contact with exposed energized conductors or equipment.
- (e) Cable and equipment shall be considered energized and worked with adequate protective devices until it has been tested de-energized with an approved device for indication of voltage and grounded with approved grounding

devices.

- (f) Cables normally energized at more than 600 volts shall be cut, spiked, or grounded at the work location. When cable is to be cut or spiked it shall be done so all employees are remote from the operation, i.e., from outside an enclosure, walk-in vault, underground structure or excavation.
- (g) Grounds will be applied except where their installation or use increases the working hazard. Grounds may be removed for test purposes.
- (h) Suitable grounding devices shall be used. They shall be first connected to a ground before being brought into contact with any de-energized conductors or equipment to be grounded. The other end shall be attached and removed by means of insulated tools or other suitable devices. When removed, they shall be removed from all conductors or equipment before being disconnected from ground.
- (i) When required, there shall be a minimum of one ground on the conductors or equipment being worked on:
 - (1) Between the place where work is being done and each possible source of supply, and/or
 - (2) At the work location.
- (j) One of the grounding devices shall be visible to at least one member of the crew unless access to the grounding device is restricted to only authorized personnel.
- (k) Grounding devices shall be capable of conducting the anticipated fault current and shall have a minimum conductance of No. 2 AWG copper.
- (l) When more than one independent crew requires the cable(s), conductor(s), or equipment to be de-energized, a tag for each such independent crew shall be placed on the cable(s), conductor(s) or equipment. Where clearances for such independent crews are controlled by a designated authority having immediate jurisdiction over cable(s), conductors(s) or equipment involved, only one tag need be installed.
- (m) Upon completion of work, the employee in charge of each independent crew shall determine that all employees in the crew are clear and shall report to the designated authority that all tags protecting the crew may be removed.
- (n) Prior to the energizing of the cable or equipment, the employee in charge shall ascertain that all employees are clear and grounds are removed.

Section 6.0 - Civil Underground Operations

6.01 Underground Installations

- (a) The estimated location of underground utility installations, such as sewer, telephone, fuel, electric, water lines, or any other underground installations that reasonably may be expected to be encountered during excavation work, shall be determined as best as possible prior to opening an excavation.
- (b) Utility companies or owners shall be contacted within established or customary local response times, advised of the proposed work, and asked to establish the location of the utility underground installations prior to the start of the actual excavation. When utility companies or owners cannot respond to a request to locate underground utility installations, the Employer may proceed to excavate with caution and provided detection equipment or other acceptable means to locate utility installations are used.

Note: Check state and local “one call” regulations prior to any excavation activities.

- (c) When excavation operations approach the estimated location of underground installations, the exact location of the installations shall be determined by safe and acceptable means (i.e., hand dig, vacuum extraction).
- (d) While the excavation is open, underground installations shall be protected, supported or removed as necessary to safeguard employees. Note: Check state and local “one call” regulations prior to any excavation activities.

6.02 Protection from Hazards Associated with Water Accumulation

- (a) Employees shall not work in excavations in which there is accumulated water unless adequate precautions have been taken to protect employees against the hazards posed by the water accumulation. The precautions necessary to protect employees adequately vary with each situation but could include special support or shield systems to protect from cave-ins, water removal to control the level of accumulating water, or use of a safety harness and lifeline.
- (b) If water is controlled or prevented from accumulating by the use of water removal equipment, the water removal equipment and operations shall be monitored by a competent person.
- (c) If excavation work interrupts the natural drainage of surface water (such as streams), diversion ditches, dikes, or other suitable means shall provide adequate drainage of the area adjacent to the excavation. Excavations subject to runoff from heavy rains will require more frequent inspections by a competent person.

6.03 Stability of Adjacent Structures

- (a) Where the stability of adjoining buildings, walls, or other structures is endangered by excavation operations, support systems such as shoring, bracing, or underpinning shall be provided to ensure the stability of such structures for the protection of employees.
- (b) Excavations below the level of the base of a footing of any foundation or retaining wall that could reasonably be expected to pose a hazard to employees shall not be permitted except when:
 - (1) A registered professional engineer has approved the determination that the structure is sufficiently removed from the excavation so as to be unaffected by the excavation activity; or
 - (2) A support system, such as underpinning, is provided to ensure the safety of employees and the stability of the structure; or
 - (3) The excavation is in stable rock; or

- (4) A registered professional engineer has approved the determination that such excavation work will not pose a hazard to employees.
- (c) Sidewalks, pavements, curbs, existing utilities, and appurtenant structures shall not be undermined unless a support system or another method of protection is provided to protect employees from the possible collapse of such structures.

6.04 Protection of Employees from loose Rock or Soil

- (a) Adequate protection shall be provided to protect employees from loose rock or soil that could pose a hazard by falling or rolling into the excavation. Such protection shall consist of scaling to remove loose material; installation of protective barricades at intervals as necessary on the face to stop and contain falling material; or other means that provide equivalent protection.
- (b) Employees shall be protected from excavated or other materials or equipment that could pose a hazard by falling or rolling into excavations. Protection shall be provided by placing and keeping such materials or equipment at least 2 feet from the edge of the excavations, or by the use of retaining devices that are sufficient to prevent materials or equipment from falling or rolling into excavations, or by a combination of both if necessary.

6.05 Inspections

- (a) Daily inspections of excavations, the adjacent areas, and protective systems shall be made by a competent person for evidence of a situation that could result in possible cave-ins, indications of failure of protective systems, hazardous atmospheres, or other hazardous conditions. An inspection shall be conducted by the competent person prior to the start of work and as needed throughout the shift. Inspections shall also be made after every rainstorm or other occurrence that may increase the hazard (e.g., heavy vibration). These inspections are only required when employee exposure can be reasonably anticipated.
- (b) Where the competent person finds evidence of a situation that could result in a possible cave-in, indications of failure of protective systems, hazardous atmospheres, or other hazardous conditions, exposed employees shall be removed from the hazardous area immediately until the necessary precautions have been taken to ensure their safety.
- (c) All inspections are to be documented and all documentation shall be retained by the employer for the duration of the job.

6.06 Fall Protection

- (a) Walkways shall be provided where employees or equipment are required or permitted to cross over excavations. Guardrails shall be provided where walkways are 6 feet or more above lower levels.
- (b) Adequate barrier physical protection shall be provided at all remotely located excavations. All wells, pits, shafts, etc., shall be barricaded or covered. Upon completion of exploration and other similar operations, temporary wells, pits, shafts, etc., shall be backfilled.

6.07 Access and Egress

- (a) Structural ramps used by employees and equipment as a means of access or egress from excavations shall be designed by a competent person.
- (b) Ramps and runways constructed of two or more structural members shall have the structural members connected together to prevent displacement.
- (c) Structural members used for ramps and runways shall be of uniform thickness.
- (d) Cleats and other appropriate means used to connect runway structural members shall be attached to the bottom of

the runway or shall be attached in a manner to prevent tripping.

- (e) Structural ramps used in lieu of steps shall be provided with cleats or other surface treatments on the top surface to prevent slipping.
- (f) A stairway, ladder, ramp or other safe means of egress shall be located in trench excavations that are 4 feet or more in depth so as to require no more than 25 feet of lateral travel for employees. Ladders must extend 3 feet beyond the surface to be accessed.

6.08 Exposure to Vehicular Traffic

Employees exposed to public vehicular traffic shall be provided with, and shall wear, warning vests or other suitable garments marked with or made of reflectorized or high-visibility material. These garments shall comply with state and local regulations.

6.09 Exposure to Falling Loads

No employee shall be permitted underneath loads handled by lifting or digging equipment. Employees shall be required to stand away from any vehicle being loaded or unloaded to avoid being struck by any spillage or falling materials. Operators may remain in the cabs of vehicles being loaded or unloaded when the vehicles are equipped with a cab shield and/or canopy adequate to protect the operator from shifting or falling materials.

6.10 Warning Systems for Mobile Equipment

When mobile equipment is operated adjacent to an excavation and the operator does not have a clear and direct view of the edge of the excavation, warning systems such as barricades, hand or mechanical signals, or stop logs shall be used.

6.11 Hazardous Atmospheres

(a) Testing and Controls

- (1) No employees shall be permitted to enter or remain within any excavation of 4' or greater unless the atmosphere has been tested and determined to be safe for entry and remains safe. The excavation shall be tested with an approved tester prior to entering, and with sufficient frequency to ensure that the development of dangerous air contamination, oxygen enrichment and/or oxygen deficiency does not occur during the performance of any operation. The employee shall determine that the instrument is calibrated and in proper working order. A written record of such testing results shall be made and kept at the worksite for the duration of the work.
- (2) If it is not feasible to ensure the removal of dangerous air contamination, oxygen enrichment and/or oxygen deficiency, this condition is likely a "Permit Required Confined Space". In such cases employees shall not enter this space and shall contact the company Safety Personnel or other qualified persons designated by the company for assistance.

(b) Emergency Rescue Equipment

- (1) Rescue Equipment: Employer shall provide equipment to ensure the prompt and safe rescue of employees from excavations.
- (2) Employees entering bell-bottom pier holes, or other similar deep and confined footing excavations, shall wear a harness with a lifeline securely attached to it. The lifeline shall be separate from any line used to handle materials and shall be individually attended at all times while the employee wearing the lifeline is in the excavation.

6.12 Chipping Procedures when Energized Cables are Present

- (a) When service load conditions or a lack of feasible alternatives require that the cable remain energized only a Journeyman Lineman or Cable Splicer or a Qualified persons under the observance of a Journeyman Lineman or Cable Splicer may slice through or chip duct work, concrete, asphalt, or similar material under the following conditions:
 - (1) The chipping or slicing is performed with the use of hand tools, such as hammer and cold chisel, with movements that could potentially penetrate the cable directed away from the cable or limited by use of tool guard to prevent contact with the cable, and non-conductive barrier is inserted (if practicable) to protect the cable from penetration once sufficient material has been broken to make that action possible, or
 - (2) Chipping or slicing performed with power tools using the following procedures: power tools are operated in a direction away from the energized cable unless tool guard are used to prevent contact with the cable; power tool are not used within 0.5 inch of an energized cable unless tool guards to prevent contact with energized cable are used; and a non-conductive protective barrier is inserted (if practicable) to protect the cable from penetration once sufficient material has been broken to make the action possible.

Section 7.0 - Protection of Employees in Excavations

7.01 General

- (a) Each employee in an excavation shall be protected from cave-ins by an adequate protective system, either sloped or shielded, except when.
- (1) Excavations are made entirely in stable rock. Or
 - (2) Excavations are less than 5 feet in depth and examination of the ground by competent person provides no indication of a potential cave-in.

Note: Some excavations 5 feet or less may require shoring, sloping, or other methods of employee protection.

- (b) Protective systems shall have the capacity to resist without failure all loads that are intended or could reasonably be expected to be applied or transmitted to the system.

7.02 Design of Sloping and Benching Systems

(a) Option 1: Allowable configurations and slopes

- (1) If soil classification as outlined in Section 7.43 is not performed and the use of sloping as the form of protection is used, then excavations shall be sloped at an angle not steeper than one and one-half horizontal to one vertical (34 degrees measured from the horizontal).
- (2) Slopes specified above Subpart P shall be excavated to form configurations that are in accordance with the slopes shown for Type C soil.

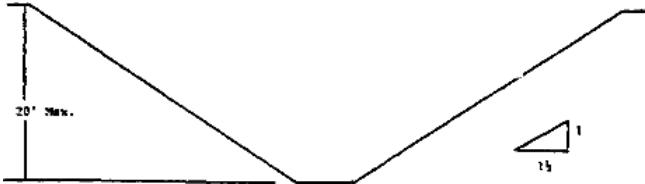
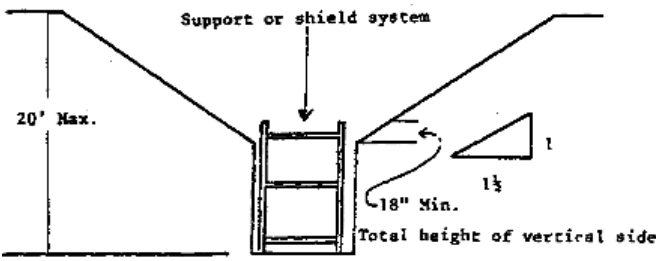
	<p>Simple Slope – General</p> <p>All simple slope excavations 20 feet or less in depth shall have a maximum allowable slope of 1-1/2 to 1.</p>
	<p>Vertical Sided Lower Portion</p> <p>All excavations 20 feet or less in depth which have vertically sided lower portions shall be shielded or supported at a height at least 18 inches above the top of the vertical side. All such excavations shall have a maximum allowable slope of 1-1/2 to 1.</p>

(b) Option 2: Determination of Slopes and Configurations using Soil Classification

- (1) Maximum allowable slopes, and allowable configurations for sloping and benching systems, shall be determined in accordance with the conditions and requirements set forth in Section 7.43 Soil Classification. Below are the configurations for Type B and Type B soils.

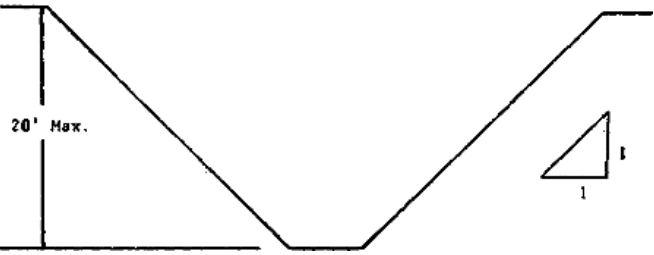
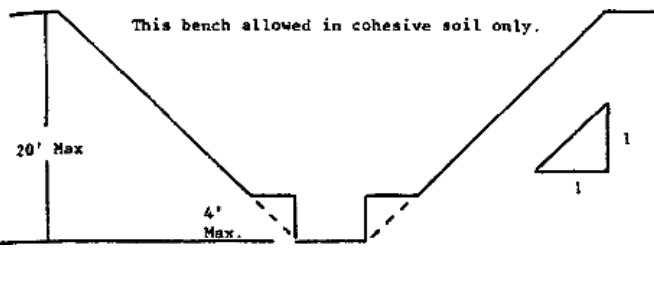
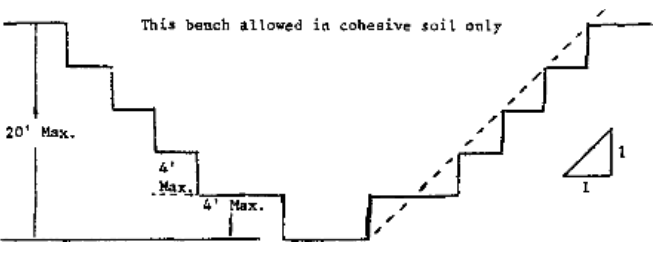
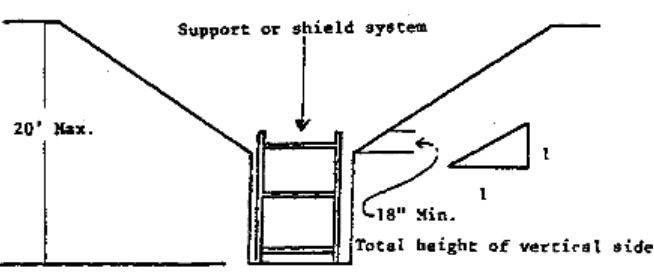
	<p>Simple Slope All simple slope excavations 20 feet or less in depth shall have a maximum allowable slope of 1 to 1.</p>
	<p>Single Bench All benched excavations 20 feet or less in depth shall have a maximum allowable slope of 1 to 1 and maximum bench dimensions as shown to the left.</p>
	<p>Multiple Bench</p>
	<p>Vertically Sided Lower All excavations 20 feet or less in depth which have vertically sided lower portions shall be shielded or supported to a height at least 18 inches above the top of the vertical side. All such excavations shall have a maximum allowable slope of 1 to 1.</p>

- (2) Maximum allowable slopes, and allowable configurations for sloping and benching systems, shall be

determined in accordance with the conditions and requirements set forth in Section 7.43 Soil Classification. Below are the configurations for Type B and Type A soils.

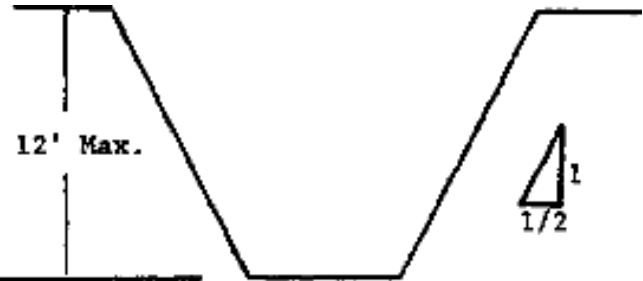
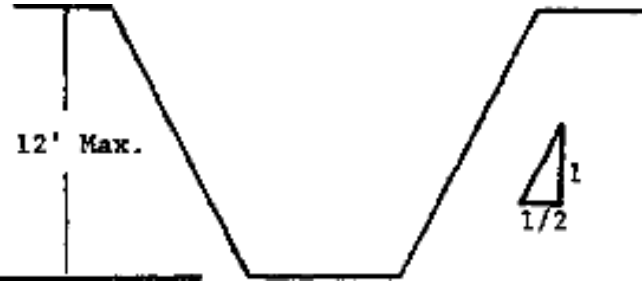
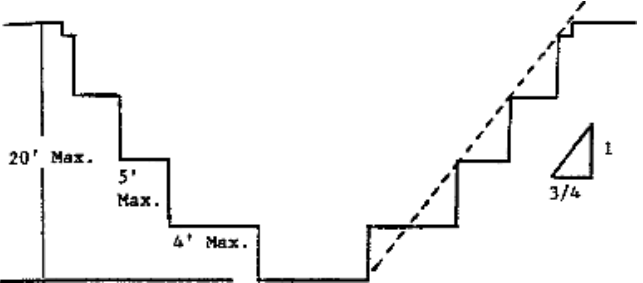
	<p>Simple Slope - General</p>
	<p>Simple Slope – Short Term Exception: Simple slope excavations which are open 24 hours or less (short term) and which are 12 feet or less in depth shall have a maximum allowable slope of 1/2 to 1.</p>
	<p>Simple Bench All benched excavations 20 feet or less in depth shall have a maximum allowable slope of 3/4 to 1 and maximum bench dimensions as shown to the left.</p>
	<p>Multiple Bench</p>

	<p>Unsupported Vertically Sided Lower Portion – Maximum 8 Feet in Depth All excavations 8 feet or less in depth which have unsupported vertically sided lower portions shall have a maximum vertical side of 3-1/2 feet.</p>
	<p>Unsupported Vertically Sided Lower Portion – Maximum 12 feet in Depth All excavations more than 8 feet but not more than 12 feet in depth which unsupported vertically sided lower portions shall have a maximum allowable slope of 1 to 1 and a maximum vertical side of 3-1/2 feet.</p>
	<p>Supported or Shielded Vertically Sided Lower Portion All excavations 20 feet or less in depth which have vertically sided lower portions that are supported or shielded shall have a maximum allowable slope of 3/4 to 1. The support or shield system must extend at least 18 inches above the top of the vertical side.</p>

- (3) Maximum allowable slopes, and allowable configurations for sloping and benching systems, shall be determined in accordance with the conditions and requirements set forth in Section 7.43 Soil Classification. Below are the configurations for Layered Soils.
- (4) All excavations 20 feet or less in depth made in layered soils shall have a maximum allowable slope for each layer as set forth below.

	<p>B Over A</p>
--	-----------------

	C Over A
	C Over B
	A Over B
	A Over C
	B Over C

(c) Option 3: Designs using other tabulated data

- (1) Designs of sloping or benching systems shall be selected from and in accordance with tabulated data, such as tables and charts of 29 CFR 1926 Subpart P or those of a Registered Professional Engineer.
- (2) The tabulated data, approved by a Registered Professional Engineer, shall be in written form and shall include all of the following:
 - i. Identification of the parameters that effect the selection of a sloping or benching system drawn from such data;

- ii. Identification of the limits of use of the data, to include the magnitude and configuration of slopes determined to be safe;
 - iii. Explanatory information as may be necessary to aid the user in making a correct selection of a protective system from the data.
- (3) At least one copy of the tabulated data which identifies the registered professional engineer who approved the data, shall be maintained at the jobsite during construction of the protective system. After that time, the data may be stored off the jobsite, but a copy of the data shall be made available to regulatory agencies upon request.

(d) Option 4: Design by a registered professional engineer

- (1) Sloping and benching systems not utilizing Option 1, Option 2, or Option 3 above shall be approved by a registered professional engineer.
- (2) Designs shall be in written form and shall include at least the following:
 - i. The magnitude of the slopes that were determined to be safe for the particular project;
 - ii. The configurations that were determined to be safe for the particular project;
 - iii. The identity of the registered professional engineer approving the design.
- (3) At least one copy of the design shall be maintained at the jobsite while the slope is being constructed. After that time the design need not be at the jobsite, but a copy shall be made available to regulatory agencies upon request.

7.03 Design of Support Systems, Shield Systems, and Other Protective Systems

- (a) Designs of support systems, shield systems, and other protective systems shall be selected and assembled under the direction of a competent person and shall be in accordance to the following:
- (b) **Option 1: Designs using Soil Classification to Determine Timber Shoring or Aluminum Hydraulic Shoring**
 - (1) Designs for timber shoring in trenches shall be determined in accordance with the conditions and requirements set forth in the tables below (Appendices C of 29 CFR 1926 Subpart P). Designs for aluminum hydraulic shoring shall be in accordance with the manufacturer's tabulated data. If the data cannot be utilized, designs shall be in accordance with Appendix D of 29 CFR 1926 Subpart P.

Timber Trench Shoring - Minimum Timber Requirements* Soil Type C

Depth of trench (feet)	Size (actual) and spacing of members**												
	Cross braces					Whales			Uprights				
	Horizontal spacing (feet)	Width of trench (feet)					Vertical spacing (feet)	Size (in.)	Vertical spacing (feet)	Maximum allowable horizontal spacing (feet)			
Up To 4		Up to 6	Up to 9	Up to 12	Up to 15	Close							
5 TO 10	Up to 6	6 x 8	6 x 8	6 x 8	8 x 8	8 x 8	5	8 x 10	5	2 x 6			
	Up to 8	8 x 8	8 x 8	8 x 8	8 x 8	8 x 10	5	10 x 12	5	2 x 6			
	Up to 10	8 x 10	8 x 10	8 x 10	8 x 10	10 x 10	5	12 x 12	5	2 x 6			
	See Note 1												
10 TO 15	Up to 6	8 x 8	8 x 8	8 x 8	8 x 8	8 x 10	5	10 x 12	5	2 x 6			
	Up to 8	8 x 10	8 x 10	8 x 10	8 x 10	10 x 10	5	12 x 12	5	2 x 6			
	See Note 1												
	See Note 1												
15 TO 20	Up to 6	8 x 10	8 x 10	8 x 10	8 x 10	10 x 10	5	12 x 12	5	3 x 6			
	See Note 1												
	See Note 1												
	See Note 1												
Over 20	See Note 1												

* Mixed oak or equivalent with a bending strength not less than 850 psi.

**Manufactured members of equivalent strength may be substituted for wood.

Timber Trench Shoring - Minimum Timber Requirements* Soil Type B

Depth of trench (feet)	Size (actual) and spacing of members**												
	Cross braces					Whales			Uprights				
	Horizontal spacing (feet)	Width of trench (feet)					Vertical spacing (feet)	Size (in.)	Vertical spacing (feet)	Maximum allowable horizontal spacing (feet)			
Up To 4		Up to 6	Up to 9	Up to 12	Up to 15	Close				2	3		
5 TO 10	Up to 6	4 x 6	4 x 6	6 x 6	6 x 6	6 x 6	5	6 x 8	5			2 x 6	
	Up to 8	6 x 6	6 x 6	6 x 6	6 x 8	6 x 8	5	8 x 10	5			2 x 6	
	Up to 10	6 x 6	6 x 6	6 x 6	6 x 8	6 x 8	5	10 x 10	5			2 x 6	
	See Note 1												
10 TO 15	Up to 6	6 x 6	6 x 6	6 x 6	6 x 8	6 x 8	5	8 x 8	5		2 x 6		
	Up to 8	6 x 8	6 x 8	6 x 8	8 x 8	8 x 8	5	10 x 10	5		2 x 6		
	Up to 10	8 x 8	8 x 8	8 x 8	8 x 8	8 x 10	5	10 x 12	5		2 x 6		
	See Note 1												
15 TO 20	Up to 6	6 x 8	6 x 8	6 x 8	8 x 8	8 x 8	5	8 x 10	5	3 x 6			
	Up to 8	8 x 8	8 x 8	8 x 8	8 x 8	8 x 10	5	10 x 12	5	3 x 6			
	Up to 10	8 x 10	8 x 10	8 x 10	8 x 10	10 x 10	5	12 x 12	5	3 x 6			
	See Note 1												
Over 20	See Note 1												

* Mixed oak or equivalent with a bending strength not less than 850 psi.

**Manufactured members of equivalent strength may be substituted for wood.

Timber Trench Shoring - Minimum Timber Requirements* Soil Type A

Depth of trench (feet)	Size (actual) and spacing of members**													
	Cross braces						Whales		Uprights					
	Horizontal spacing (feet)	Width of trench (feet)					Vertical spacing (feet)	Size (in.)	Vertical spacing (feet)	Maximum allowable horizontal spacing (feet)				
Up To 4		Up to 6	Up to 9	Up to 12	Up to 15	Close				4	5	6	8	
5 TO 10	Up to 6	4 x 4	4 x 4	4 x 6	6 x 6	6 x 6	4	Not rqrd					2 x 6	
	Up to 8	4 x 4	4 x 4	4 x 6	6 x 6	6 x 6	4	Not rqrd						2 x 8
	Up to 10	4 x 6	4 x 6	4 x 6	6 x 6	6 x 6	4	8 x 8	4			2 x 6		
	Up to 12	4 x 6	4 x 6	6 x 6	6 x 6	6 x 6	4	8 x 8	4				2 x 6	
10 TO 15	Up to 6	4 x 4	4 x 4	4 x 6	6 x 6	6 x 6	4	Not rqrd					3 x 8	
	Up to 8	4 x 6	4 x 6	6 x 6	6 x 6	6 x 6	4	8 x 8	4		2 x 6			
	Up to 10	6 x 6	6 x 6	6 x 6	6 x 8	6 x 8	4	8 x 10	4			2 x 6		
	Up to 12	6 x 6	6 x 6	6 x 6	6 x 8	6 x 8	4	10 x 10	4				3 x 8	
15 TO 20	Up to 6	6 x 6	6 x 6	6 x 6	6 x 8	6 x 8	4	6 x 8	4		3 x 6			
	Up to 8	6 x 6	6 x 6	6 x 6	6 x 8	6 x 8	4	8 x 8	4		3 x 6			
	Up to 10	8 x 8	8 x 8	8 x 8	8 x 8	8 x 10	4	8 x 10	4		3 x 6			
	Up to 12	8 x 8	8 x 8	8 x 8	8 x 8	8 x 10	4	10 x 10	4		3 x 6			
Over 20	See Note 1													

* Mixed oak or equivalent with a bending strength not less than 850 psi.
 **Manufactured members of equivalent strength may be substituted for wood.

Timber Trench Shoring - Minimum Timber Requirements* Soil Type C

Depth of trench (feet)	Size (actual) and spacing of members**													
	Cross braces						Whales		Uprights					
	Horizontal spacing (feet)	Width of trench (feet)					Vertical spacing (feet)	Size (in.)	Vertical spacing (feet)	Maximum allowable horizontal spacing (feet)				
Up To 4		Up to 6	Up to 9	Up to 12	Up to 15	Close								
5 TO 10	Up to 6	6 x 6	6 x 6	6 x 6	6 x 6	8 x 8	5	8 x 8	5		3 x 6			
	Up to 8	6 x 6	6 x 6	6 x 6	8 x 8	8 x 8	5	10 x 10	5		3 x 6			
	Up to 10	6 x 6	6 x 6	8 x 8	8 x 8	8 x 8	5	10 x 12	5		3 x 6			
	See Note 1													
10 TO 15	Up to 6	6 x 8	6 x 8	6 x 8	8 x 8	8 x 8	5	10 x 10	5		4 x 6			
	Up to 8	8 x 8	8 x 8	8 x 8	8 x 8	8 x 8	5	12 x 12	5		4 x 6			
	See Note 1													
	See Note 1													
15 TO 20	Up to 6	8 x 8	8 x 8	8 x 8	8 x 10	8 x 10	5	10 x 12	5		4 x 6			
	See Note 1													
	See Note 1													
	See Note 1													
Over 20	See Note 1													

* Douglas Fir or equivalent with a bending strength not less than 1500 psi.
 **Manufactured members of equivalent strength may be substituted for wood.

Timber Trench Shoring -Minimum Timber Requirements* Soil Type B

Depth of trench (feet)	Size (S4S) and spacing of members**													
	Horizontal spacing (feet)	Cross braces					Vertical spacing (feet)	Whales		Uprights				
		Width of trench (feet)						Size (in.)	Vertical spacing (feet)	Maximum allowable horizontal spacing (feet)				
	Up To 4	Up to 6	Up to 9	Up to 12	Up to 15					Close	2	3		4 x 12
5 TO 10	Up to 6	4 x 6	4 x 6	4 x 6	6 x 6	6 x 6	5	6 x 8	5			4 x 8	4 x 8	
	Up to 8	4 x 6	4 x 6	6 x 6	6 x 6	6 x 6	5	8 x 8	5	3 x 8				
	Up to 10	4 x 6	4 x 6	6 x 6	6 x 6	6 x 8	5	8 x 10	5		4 x 8			
	See Note 1													
10 TO 15	Up to 6	6 x 6	6 x 6	6 x 6	6 x 8	6 x 8	5	8 x 8	5	3 x 6	4 x 10			
	Up to 8	6 x 8	6 x 8	6 x 8	8 x 8	8 x 8	5	10 x 10	5	3 x 6	4 x 10			
	Up to 10	6 x 8	6 x 8	8 x 8	8 x 8	8 x 8	5	10 x 12	5	3 x 6	4 x 10			
	See Note 1													
15 TO 20	Up to 6	6 x 8	6 x 8	6 x 8	6 x 8	8 x 8	5	8 x 10	5	4 x 6				
	Up to 8	6 x 8	6 x 8	6 x 8	8 x 8	8 x 8	5	10 x 12	5	4 x 6				
	Up to 10	8 x 8	8 x 8	8 x 8	8 x 8	8 x 8	5	12 x 12	5	4 x 6				
	See Note 1													
Over 20	See Note 1													

* Douglas Fir or equivalent with a bending strength not less than 1500 psi.

**Manufactured members of equivalent strength may be substituted for wood.

Timber Trench Shoring - Minimum Timber Requirements* Soil Type A

Depth of trench (feet)	Size (S4S) and spacing of members**													
	Horizontal spacing (feet)	Cross braces					Vertical spacing (feet)	Whales		Uprights				
		Width of trench (feet)						Size (in.)	Vertical spacing (feet)	Maximum allowable horizontal spacing (feet)				
	Up To 4	Up to 6	Up to 9	Up to 12	Up to 15					Close	4	5	6	8
5 TO 10	Up to 6	4 x 4	4 x 4	4 x 4	4 x 4	4 x 6	4	Not rgrd	Not rgrd			4 x 6		
	Up to 8	4 x 4	4 x 4	4 x 4	4 x 6	4 x 6	4	Not rgrd	Not rgrd				4 x 8	
	Up to 10	4 x 6	4 x 6	4 x 6	6 x 6	6 x 6	4	8 x 8	4		4 x 6			
	Up to 12	4 x 6	4 x 6	4 x 6	6 x 6	6 x 6	4	8 x 8	4			4 x 6		
	Up to 6	4 x 4	4 x 4	4 x 4	6 x 6	6 x 6	4	Not rgrd	Not rgrd				4 x 10	
10 TO 15	Up to 8	4 x 6	4 x 6	4 x 6	6 x 6	6 x 6	4	6 x 8	4		4 x 6			
	Up to 10	6 x 6	6 x 6	6 x 6	6 x 6	6 x 6	4	8 x 8	4		4 x 8			
	Up to 12	6 x 6	6 x 6	6 x 6	6 x 6	6 x 6	4	8 x 10	4	4 x 6		4 x 10		
15 TO 20	Up to 6	6 x 6	6 x 6	6 x 6	6 x 6	6 x 6	4	6 x 8	4	3 x 6				
	Up to 8	6 x 6	6 x 6	6 x 6	6 x 6	6 x 6	4	8 x 8	4	3 x 6	4 x 12			
	Up to 10	6 x 6	6 x 6	6 x 6	6 x 6	6 x 8	4	8 x 10	4	3 x 6				
	Up to 12	6 x 6	6 x 6	6 x 6	6 x 8	6 x 8	4	8 x 12	4	3 x 6	4 x 12			
Over 20	See Note 1													

* Douglas Fir or equivalent with a bending strength not less than 1500 psi.

**Manufactured members of equivalent strength may be substituted for wood.

Aluminum Hydraulic Shoring Vertical Shores for Soil Type B

Depth of trench (feet)	Hydraulic cylinders				
	Maximum horizontal spacing	Maximum vertical spacing	Width of trench (feet)		
			Up to 8	Over 8 up to 12	Over 12 up to 15
Over 5 up to 10	8	4	2 inch dia	2 inch dia (Note 2)	3 inch dia
Over 10 up to 15	6.5				
Over 15 up to 20	5.5				
Over 20	Note 1				

Note 1: For applications other than those listed in the tables, refer to 7.03 (c) Option 2: Designs using manufacturer's tabulated data. For trench depths in excess of 20 feet, refer to 7.08 (c) (1) and 7.08 (c) (2).

Note 2: 2 inch diameter cylinders, at this width, shall have structural steel tube (3.5 x 3.5 x 0.1875) oversleeves, or structural oversleeves of manufacturer's specification, extending the full, collapsed length.

Aluminum Hydraulic Shoring Vertical Shores for Soil Type A

Depth of trench (feet)	Hydraulic cylinders				
	Maximum horizontal spacing (feet)	Maximum vertical spacing (feet)	Width of trench (feet)		
			Up to 8	Over 8 up to 12	Over 12 up to 15
Over 5 up to 10	8	4	2 inch dia	2 inch dia (Note 2)	3 inch dia
Over 10 up to 15	8				
Over 15 up to 20	7				
Over 20	Note 1				

Note 1: For applications other than those listed in the tables, refer to 7.03 (c) Option 2: Designs using manufacturer's tabulated data. For trench depths in excess of 20 feet, refer to 7.08 (c) (1) and 7.08 (c) (2).

Note 2: 2 inch diameter cylinders, at this width, shall have structural steel tube (3.5 x 3.5 x 0.1875) oversleeves, or structural oversleeves of manufacturer's specification, extending the full, collapsed length.

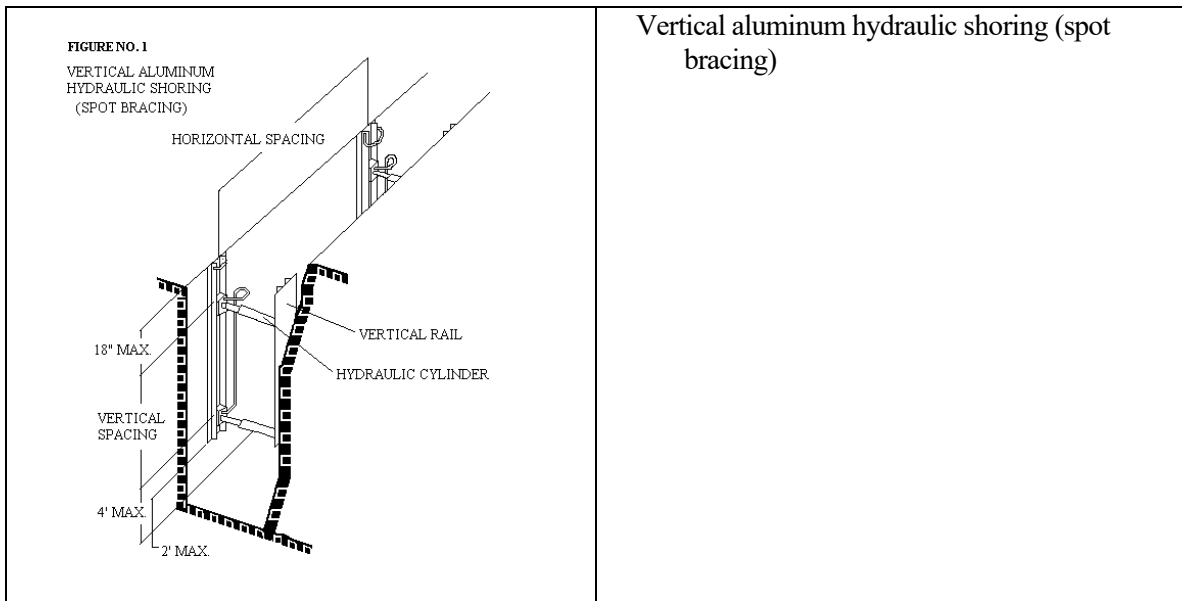

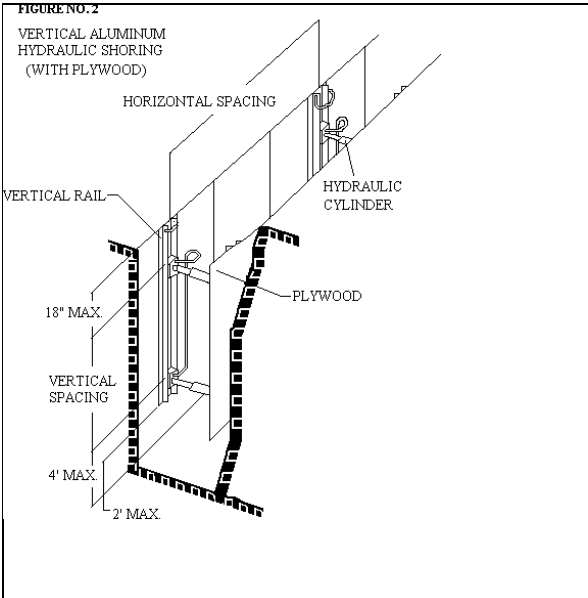

Vertical aluminum hydraulic shoring (with plywood)

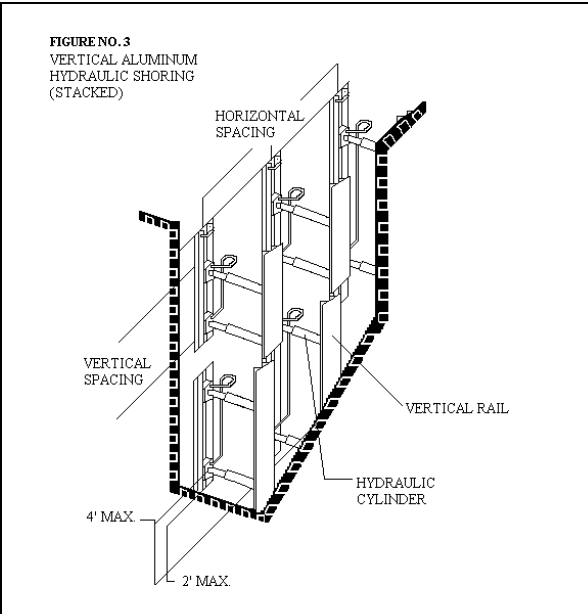

Vertical aluminum hydraulic shoring (stacked)

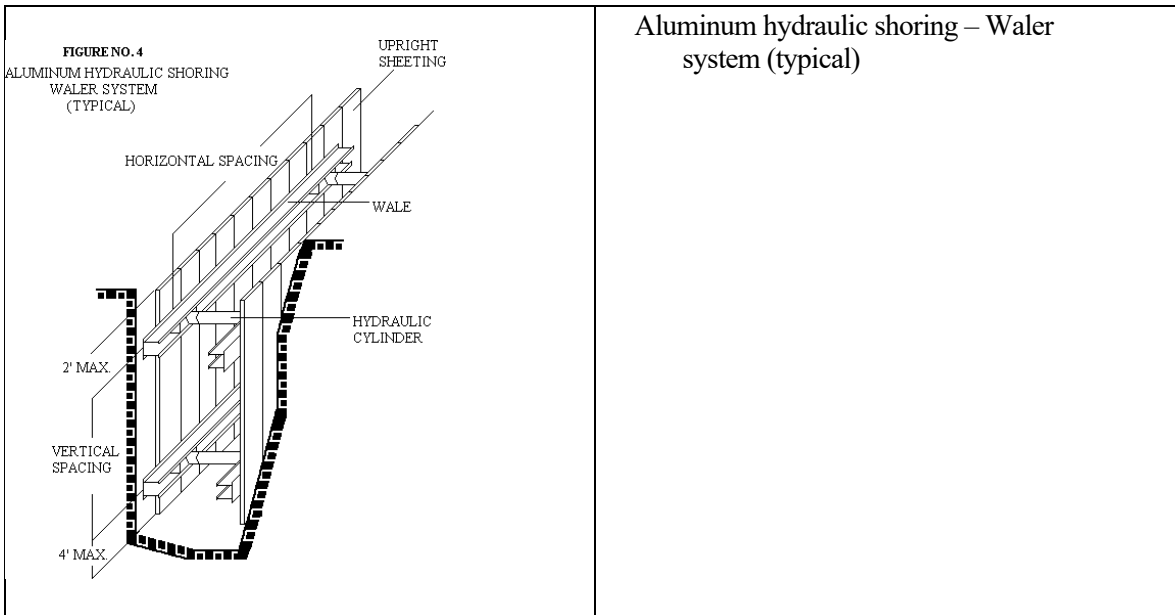

Aluminum hydraulic shoring – Waler system (typical)

Aluminum Hydraulic Shoring Waler System for Soil Type C

Depth of trench (feet)	Wales		Hydraulic cylinders						Timber uprights		
	Vertical spacing (feet)	Section modulus* (in. ³)	Width of trench (feet)						Max horiz spacing (on center)		
			Up to 8		Over 8 up to 12		Over 12 up to 15		Solid sheet	2 ft.	3 ft.
			Horizontal spacing	Cylinder dia	Horizontal spacing	Cylinder dia	Horizontal spacing	Cylinder dia			
Over 5 up to 10	4	3.5	6.0	2 in.	6.0	2 in. Note 2	6.0	3 in.	3 x 12		
		7.0	6.5	2 in.	6.5	2 in. Note 2	6.5	3 in.			
		14.0	10.0	3 in.	10.0	3 in.	10.0	3 in.			
Over 10 up to 15	4	3.5	4.0	2 in.	4.0	2 in. Note 2	4.0	3 in.	3 x 12		
		7.0	5.5	3 in.	5.5	3 in.	5.5	3 in.			
		14.0	8.0	3 in.	8.0	3 in.	8.0	3 in.			
Over 15 up to 20	4	3.5	3.5	2 in.	3.5	2 in. Note 2	3.5	3 in.	3 x 12		
		7.0	5.0	3 in.	5.0	3 in.	5.0	3 in.			
		14.0	6.0	3 in.	6.0	3 in.	6.0	3 in.			
Over 20	Note 1										

Note 1: For applications other than those listed in the tables, refer to 7.03 (c) Option 2: Designs using manufacturer's tabulated data. For trench depths in excess of 20 feet, refer to 7.08 (c) (1) and 7.08 (c) (2).

Note 2: 2 inch diameter cylinders, at this width, shall have structural steel tube (3.5 x 3.5 x 0.1875) oversleeves, or structural oversleeves of manufacturer's specification, extending the full, collapsed length.

* Consult product manufacturer and/or qualified engineer for Section Modulus of available wales.

Aluminum Hydraulic Shoring Waler System for Soil Type B

Depth of trench (feet)	Wales		Hydraulic cylinders						Timber uprights			
	Vertical spacing (feet)	Section modulus* (in. ³)	Width of trench (feet)						Max horiz spacing (on center)			
			Up to 8		Over 8 up to 12		Over 12 up to 15		Solid sheet	2 ft.	3 ft.	
			Horizontal spacing	Cylinder dia	Horizontal spacing	Cylinder dia	Horizontal spacing	Cylinder dia				
Over 5 up to 10	4	3.5	8.0	2 in.	8	2 in. Note 2	8.0	3 in.			3 x 12	
		7.0	9.0	2 in.	9	2 in. Note 2	9.0	3 in.				
		14.0	12.0	3 in.	12	3 in.	12.0	3 in.				
Over 10 up to 15	4	3.5	6.0	2 in.	6	2 in. Note 2	6.0	3 in.		3 x 12		
		7.0	8.0	3 in.	8	3 in.	8.0	3 in.				
		14.0	10.0	3 in.	10	3 in.	10.0	3 in.				
Over 15 up to 20	4	3.5	5.5	2 in.	5.5	2 in. Note 2	5.5	3 in.	3 x 12			
		7.0	6.0	3 in.	6	3 in.	6.0	3 in.				
		14.0	9.0	3 in.	9	3 in.	9.0	3 in.				
Over 20					Note 1							

Note 1: For applications other than those listed in the tables, refer to 7.03 (c) Option 2: Designs using manufacturer’s tabulated data. For trench depths in excess of 20 feet, refer to 7.08 (c) (1) and 7.08 (c) (2).

Note 2: 2 inch diameter cylinders, at this width, shall have structural steel tube (3.5 x 3.5 x 0.1875) oversleeves, or structural oversleeves of manufacturer's specification, extending the full, collapsed length.

* Consult product manufacturer and/or qualified engineer for Section Modulus of available wales.

(c) Option 2: Designs using manufacturer’s tabulated data

- (1) Designs of support systems, shield systems, or other protective systems that are drawn from manufacturer’s tabulated data shall be in accordance with all specifications, recommendations, and limitations issued or made by the manufacturer.
- (2) Deviation from the specifications, recommendations, and limitations issued or made by the manufacturer shall only be allowed after the manufacturer issues specific written approval.
- (3) Manufacturer’s specifications, recommendations, and limitations, and manufacturer’s approval to deviate from the specifications, recommendations, and limitations shall be in written form at the jobsite during construction of the protective system. After that time this data may be stored off the jobsite, but a copy shall be made available to regulatory agencies upon request.

(d) Option 3: Designs using other tabulated data

- (1) Designs of support systems, shield systems, or other protective systems shall be selected from and be in accordance with tabulated data, such as charts and tables approved by a Registered Professional Engineer.
- (2) The tabulated data shall be in written form and include all of the following:
 - (a) Identification of the parameters that effect the selection of a protective system drawn from such data;
 - (b) Identification of the limits of use of the data;

(c) Explanatory information as may be necessary to aid the user in making a correct selection of a protective system from the data.

(3) At least one copy of the tabulated data, which identifies the Registered Professional Engineer who approved the data, shall be maintained at the jobsite during construction of the protective system. After that time the data may be stored off the jobsite, but a copy of the data shall be made available to regulatory agencies upon request.

(e) **Option 4: Design by a Registered Professional Engineer**

(1) Support systems, shield system, or other protective systems not utilizing Option 1, Option 2, or Option 3, above, shall be approved by a Registered Professional Engineer.

(2) Designs shall be in written form and shall include the following:

i. A plan indicating the sizes, types, and configurations of the materials to be used in the protective system; and

ii. The identity of the registered professional engineer approving the design.

(3) At least one copy of the design shall be maintained at the jobsite during construction of the protective system. After that time, the design may be stored off the jobsite, but a copy must be made available to regulatory agencies upon request.

7.04 Materials and Equipment

(a) Materials and equipment used for protective systems shall be free from damage or defects that might impair their proper function.

(b) Manufactured materials and equipment used for protective systems shall be used and maintained in a manner that is consistent with the recommendations of the manufacturer, and in a manner that will prevent employee exposure to hazards.

(c) When material or equipment that is used for protective systems is damaged, a competent person shall examine the material or equipment and evaluate its suitability for continued use.

Note: If the competent person cannot assure the material or equipment is able to support the intended loads or is otherwise suitable for safe use, then such material or equipment shall be removed from service and shall be evaluated and approved by a registered professional engineer before returning to service.

7.05 Installation and Removal of Support

(a) Members of support systems shall be securely connected together to prevent sliding, falling, kickouts, or other predictable failure.

(b) Support systems shall be installed and removed in a manner that protects employees from cave-ins, structural collapses, or from being struck by members of the support system.

(c) Individual members of support systems shall not be subjected to loads exceeding those which they were designed to withstand.

- (d) Before temporary removal of individual members begin, additional precautions shall be taken to ensure the safety of employees, such as installing other structural members to carry the loads imposed on the support system.
- (e) Removal shall begin at, and progress from, the bottom of the excavation. Members shall be released slowly as to note any indication of possible failure of the remaining members of the structure or possible cave-in of the sides of the excavations.
- (f) Backfilling shall progress together with the removal of support systems from excavations.
- (g) Excavation of material to a level no greater than 2 feet below the bottom of the members of a support system shall be permitted, but only if the system is designed to resist the forces calculated for the full depth of the trench, and there are no indications while the trench is open of a possible loss of soil from behind or below the bottom of the support system.
- (h) Installation of a support system shall be closely coordinated with the excavation of trenches.

7.06 Sloping and Benching Systems

- (a) Employees shall not be permitted to work on the faces of sloped or benched excavations at levels above other employees except when employees at the lower levels are adequately protected from the hazard of falling, rolling, or sliding material or equipment.

7.07 Shielding Systems

- (a) Shield systems shall not be subjected to loads exceeding those which the system was designed to withstand.
- (b) Shields shall be installed in a manner to restrict lateral or other hazardous movement of the shield in the event of the application of sudden lateral loads.
- (c) Employees shall be protected from the hazard of cave-ins when entering or exiting areas protected by shields.
- (d) Employees shall not be allowed in shields when shields are being installed, removed, or moved vertically.
- (e) Excavations of earth material to a level not greater than 2 feet below the bottom of a shield shall be permitted, but only if the shield is designed to resist the forces calculated for the full depth of the trench, and there are no indications while the trench is open of a possible loss of soil from behind the bottom of the shield.

7.08 Soil Classification

- (a) Requirements: Each soil and rock deposit shall be classified by a competent person as Stable Rock Type A, Type B or Type C.
- (b) Basis of classification: The classification of the deposits shall be made based on the results of at least one visual and at least one manual analysis. Analysis shall be in accordance with ASTM, or the U.S. Department of Agriculture textural classification system.
- (c) Visual and manual analyses

- (1) The analyses shall be conducted to provide sufficient quantitative and qualitative information as may be necessary to identify properly the properties, factors, and conditions affecting the classification of the deposits. If the competent person is unable to classify the soil, then Type C shall be noted.
 - i. Visual analysis is conducted to determine qualitative information regarding the excavation site in general, the soil adjacent to the excavation, the soil forming the sides of the open excavation, and the soil taken as samples from excavated material.
 - ii. Observe samples of soil that are excavated and soil in the sides of the excavation. Estimate the range of particle sizes and the relative amounts of the particle sizes. Soil that is primarily composed of fine-grained material is cohesive material. Soil composed of primarily coarse-grained material is granular material.
 - iii. Observe soil as it is excavated. Soil that remains in clumps when excavated is cohesive. Soil that breaks up easily and does not stay in clumps is granular.
 - iv. Observe the side of the opened excavation and the surface area adjacent to the excavation. Crack-like openings such as tension cracks could indicate fissured material. If chunks of soil spall off a vertical side, the soil could be fissured. Small spalls are evidence of moving ground and are indications of potentially hazardous situations.
 - v. Observe the area adjacent to the excavation and the excavation itself for evidence of existing utility or other underground structures, and to identify previously disturbed soils.
 - vi. Observe the opened side of the excavation to identify layered systems. Examine layered systems to identify if the layers slope toward the excavation. Estimate the degree of slope of the layers.
 - vii. Observe the area adjacent to the excavation and the sides of the opened ion for evidence of surface water, water seeping from the sides of the excavation, or the location of the level of the watertable.
 - viii. Observe the area adjacent to the excavation and the area within the excavation for sources of vibration that may affect the stability of the excavation face.
- (2) Manual analysis of soil samples is conducted to determine quantitative as well as qualitative properties of soil and to provide more information in order to classify soil properly.
 - i. Plasticity: Mold a moist or wet sample of soil into a ball and attempt to roll it into threads as thin as 1/8-inch in diameter. Cohesive material can be successfully rolled into threads without crumbling. For example, if at least a two-inch length of 1/8-inch thread can be held on one end without tearing, the soil is cohesive.
 - ii. Dry strength: If the soil is dry and crumbles on its own or with moderate pressure into individual grains or fine powder, it is granular (any combination of gravel, sand, or silt). If the soil is dry and falls into clumps which break up into smaller clumps, but the smaller clumps can only be broken up with difficulty, it may be clay in any combination with gravel, sand, or silt. If the

dry soil breaks into clumps which do not break up into small clumps and which can only be broken with difficulty, and there is no visual indication the soil is fissured, the soil may be considered unfissured.

- iii. Thumb penetration: The thumb penetration test can be used to estimate the unconfined compressive strength of cohesive soils. (This test is based on the thumb penetration test described in ASTM Standard designation D2488 - "Standard Recommended Practice for Description of Soils (Visual-Manual Procedure).") Type A soils with an unconfined compressive strength of 1.5 tsf can readily be indented by the thumb; however, they can be penetrated by the thumb only with very great effort. Type C soils with an unconfined compressive strength of 0.5 tsf can be easily penetrated several inches by the thumb and can be molded by light finger pressure. This test should be conducted on an undisturbed soil sample, such as a large clump of soil, as soon as practicable after excavation to keep to a minimum the effects of exposure to drying influences. If the excavation is later exposed to wetting influences (rain, flooding), the classification of the soil must be changed accordingly.
- iv. Other strength tests: Estimates of unconfined compressive strength of soils can also be obtained by use of a pocket penetrometer or by using a hand-operated shear vane.
- v. Drying test: The basic purpose of the drying test is to differentiate between cohesive materials with fissures, unfissured cohesive material, and granular material. The procedure for the drying test involves drying a sample that is approximately one inch thick and six inches in diameter until it is thoroughly dry.
- vi. If the sample develops cracks as it dries, significant fissures are indicated.
- vii. Samples that dry without cracking are to be broken by hand. If considerable force is necessary to break a sample, the soil has significant cohesive material content. The soil can be classified as an unfissured cohesive material and the unconfined compressive strength should be determined.
- viii. If a sample breaks easily by hand, it is either fissured cohesive material or a granular material. To distinguish between the two, pulverize the dried clumps of the sample by hand or by stepping on them. If the clumps do not pulverize easily, the material is cohesive with fissures. If they pulverize easily into very small fragments, the material is granular.
- ix. Layered systems - In a layered soil system where there are various levels of soil classes, the system shall be classified in accordance with its weakest layer.
- x. Reclassification - If, after classifying a deposit, the properties, factors, or conditions affecting its classification change in any way, the changes shall be evaluated by a competent person. The deposit shall be reclassified to reflect the change.

7.09 Sloping and Benching

(a) Maximum Allowable Slope

- (1) The maximum allowable slope for all soil or rock deposits shall be determined from Table B-1 of 29 CFR 1926 Subpart P

TABLE B-1 MAXIMUM ALLOWABLE SLOPES	
SOIL OR ROCK TYPE	MAXIMUM ALLOWABLE SLOPES (H:V)(1) FOR EXCAVATIONS LESS THAN 20 FEET DEEP(3)
STABLE ROCK TYPE A (2) TYPE B TYPE C	VERTICAL (90 DEG.) 3/4 :1 (53 DEG.) 1:1 (45 DEG.) 1 1/2:1 (34 DEG.)
<p>Footnote (1) Numbers shown in parenthesis next to maximum allowable slopes are angles expressed in degrees from the horizontal. Angles have been rounded off.</p> <p>Footnote (2) A short-term maximum allowable slope of 1/2H:1V (63 degrees) is allowed in excavations in Type A soil that are 12 feet (3.67 m) or less in depth. Short-term maximum allowable slopes for excavations greater than 12 feet (3.67 m) in depth shall be 3/4H:1V (53 degrees).</p> <p>Footnote (3) Sloping or benching for excavations greater than 20 feet deep shall be designed by a registered professional engineer</p>	

(b) Actual Slope

- (1) The actual slope shall be less steep than the maximum allowable slope, when there are signs of distress. If that situation occurs, the slope shall be cut back to an actual slope which is at least 1/2 horizontal to one vertical (1/2H:1V) less steep than the maximum allowable slope.
- (2) When surcharge loads from stored material or equipment, operating equipment, or traffic are present, a competent person shall determine the degree to which the actual slope must be reduced below the maximum allowable slope and shall assure that such reduction is achieved.

(c) Awareness Training

- (1) All employees who work in excavations and trenches shall have the following awareness training. This can be accomplished through tail-gate sessions:

(a) Definition of an excavation

(b) Recognition of the general hazards associated with excavation and trenching

- (c) A discussion of specific hazards associated with the jobsite
- (d) The reason for, proper use, and limitations of protective equipment
- (e) How to respond to emergencies
- (f) Duties and responsibilities of employees
- (d) Specific Training
 - (1) Competent person shall be trained in the following:
 - (a) Soil analysis;
 - (b) The use of protective systems;
 - (c) Requirements of this program; and First Aid / CPR
 - (2) All training shall be documented by the employer.
 - (3) Soil classification records and any protective system designs shall be kept at the jobsite with copies forwarded to the Employers office.
 - (4) Trenching and shoring checklists shall be forwarded to the Employers office.

Section 8.0 - Energized Switchyards and High Voltage Substations

8.01 Work Near Energized Equipment and Facilities

- (a) No person other than a journey level worker shall perform work or take any conductive object within the area where there is a hazard of contact with energized conductors, unless they are directly under the observation of a Journeyman Lineman/Cable Splicer and/or Substation Technician.
- (b) When working around energized equipment, precautions shall be taken to prevent any material or tools from accidentally contacting energized conductors or equipment.
- (c) Temporary barriers. Suitable temporary barriers in or adjacent to the work area shall be used to prevent accidental contact by workers with energized high voltage equipment.
- (d) Tape barricades. Suitable barricade tape shall be used to mark off and bar approach to dangerous areas. An employee shall not be permitted to cross over or under the tape while it is barricading an area, except in an emergency or when work in progress requires the employee to enter the dangerous area. While in the area, they shall be continuously watched by a qualified person for the purpose of preventing an accident.
- (e) Use of vehicles, gin poles, cranes and other equipment in restricted or hazardous areas shall at all times be controlled by designated employees.
- (f) When operated by a Qualified Person, mobile cranes, hoists and derricks shall not be permitted closer to exposed energized conductors or equipment than the distances set forth below.

Working Distance

- (g) The following table lists the minimum working distance from energized conductors or apparatus which are not properly covered with approved protective equipment. This includes extended reach, falling, and material or equipment whether insulated or not.

Nominal voltage in kilovolts	Distance Phase to ground exposure	Distance Phase to Phase exposure
0.05 to .300	Avoid contact	Avoid contact
0.301 to 1.0	1'-9" (0.33m)	1'-9" (0.33m)
1.1 to 15.0	2'-2" (0.65m)	2'-3" (0.68m)
15.1 to 36.0	2'-7" (0.77m)	3'-0" (0.89m)
36.1 to 46.0	2'-10" (0.84m)	3'-3" (0.98m)
46.1 to 72.5	3'-4" (1.00m)	4'-0" (1.20m)
72.6 to 121.0	3'-9" (1.13m)	4'-8" (1.42m)
121.1 to 145.0	4'-4" (1.30m)	5'-5" (1.62m)
145.1 to 169.0	4'-10" (1.46m)	6'-5" (1.92m)
169.1 to 242.0	6'-8" (2.01m)	10'-2" (3.08m)
242.1 to 362.0	11'-3" (3.41m)	18'-2" (5.52m)
362.1 to 550.0	16.8" (5.07m)	27'-1" (8.24m)
550.1 to 800.0	22.7" (6.88m)	37'-5" (11.38m)

Altitude	Correction Factor
3,000' (900m)	1.00
4,000' (1,200m)	1.02
5,000' (1,500m)	1.05
6,000' (1,800m)	1.08
7,000' (2,100m)	1.11
8,000' (2,400m)	1.14
9,000' (2,700m)	1.17
10,000' (3,000m)	1.20
12,000' (3,600m)	1.25
14,000' (4,200m)	1.30
16,000' (4,800m)	1.35
18,000' (5,400m)	1.39
20,000' (6,000m)	1.44

NOTE: Applicable minimum approach distance may vary based on customer transient overvoltage (TOV) studies. If TOV studies are available refer to the minimum approach distances provided by the customer.

- (h) When operated by a Non- Qualified Person, mobile cranes, hoists and derricks shall be positioned, equipped, protected, and/or operated so that no part comes closer to energized power lines than indicated in the below table:

TABLE A—MINIMUM CLEARANCE DISTANCES

Voltage (nominal, kV, alternating current)	Minimum clearance distance (feet)
up to 50	10
over 50 to 200	15
over 200 to 350	20
over 350 to 500	25
over 500 to 750	35
over 750 to 1,000	45
over 1,000	(as established by the utility owner/operator or registered professional engineer who is a qualified person with respect to electrical power transmission and distribution).

Note 1: The value that follows "to" is up to and includes that value. For example, over 50 to 200 means up to and including 200kV.

- (i) Grounding. Refer to Sections 2.07 and 5.07.
- (j) Access to Insulators. The Employer shall furnish suitable aerial lift equipment, portable platforms, or other devices to permit employees to work on insulators or bushings attached to poles, towers, structures, or equipment when such insulators or bushings are not otherwise accessible.

Section 9.0 - Procedures for Helicopter Work

9.01 Safety

While the Employer and Union recognize that the Employer has sole responsibility for the health and safety of all the workmen on the job, and that helicopter work can be more hazardous than the conventional methods, the following rules and guidelines shall be followed:

Operating Certification

The helicopter service provider must hold appropriate certification and have a current "FAA Operating Certificate" for the category of operation being performed. (Reference 14 C.F.R. Parts 133, 135, and 137 – Contact the local Flight Standard District Office (FSDO) for assistance.)

Personnel

- (1) All personnel must be physically and mentally able and qualified to perform the work to which they are assigned, including being knowledgeable in these rules.
- (2) There must be a sufficient number of qualified ground personnel to safely guide, secure, hook and unhook the load.
- (3) No employee shall perform or be ordered or assigned to perform any activity for which they are not trained, qualified, and competent or which they may compromise their safety or the safety of others.

Job Briefing and Hazard Analysis

- (1) Before the commencement of any construction, maintenance, or lifting activity using a helicopter, a job hazard analysis (JHA) must be developed, which, at a minimum, must:
 - (a) Define the core tasks;
 - (b) Identify specific hazards;
 - (c) Identify mission specific tasks;
 - (d) Describe procedures or controls used to safely manage or mitigate the hazards;
 - (e) Describe the communication procedure to be used with the crew;
 - (f) Discuss fatigue, and methods to eliminate or mitigate it;
 - (g) Specify minimum approach distances (MAD);
 - (h) Describe a site-specific emergency action plan.
- (2) A site-specific job briefing must be held each day construction, maintenance, or lifting activities using a helicopter are performed. The daily job briefing at a minimum must:
 - (a) Summarize or recap the content of the JHA as applicable to the day's duties;

- (b) Communicate any site-specific hazards not identified in the JHA and provide mitigation for those hazards;
 - (c) Identify or establish roles for each person who will be interfacing with the aircraft or its load;
 - (d) Describe the communication procedure to be used with the crew;
 - (e) Specify minimum approach distances (MAD) from energized electrical lines in the work area;
 - (f) Describe the applicable sections of the site-specific emergency action plan, such as the location of first aid equipment and rescue gear.
- (3) An additional job briefing must be held immediately if working conditions change during the course of the job. Working conditions would include weather, wind, and visibility. During the job briefing all affected employees and others, including signalpersons, ground workers, pilot(s), must be advised of the hazards including a change of operation, if needed.
- (a) The pilot and the lineman have the ultimate decision latitude in determining the safest method to use, within company, state, federal, and FAA regulations given all the circumstances of a particular job situation.
 - (b) Employees refusing to follow safety procedures shall be immediately removed from the project. Work to be performed with helicopters shall be on a voluntary basis. Employees shall not be discriminated against by the Employer for not volunteering to work with helicopters. If the employees and/or Employer determine the work is being done in an unsafe or unprofessional manner, the work will be discontinued until the unsafe conditions are corrected.

Pilot's Responsibility

- (1) The pilot and person in charge must ensure the pilot is properly rested and fit for duty.
- (2) The helicopter pilot shall be responsible for the size, weight and way loads are connected to the helicopter.
- (3) No load shall be made if the helicopter pilot believes the lift cannot safely be performed. The person in charge shall make certain the pilot is able to freely exercise their prerogative and judgment as to safe operation of the helicopter itself concerning size, weight and manner by which loads are connected.
- (4) No employee shall work on, under, near or in conjunction with a helicopter whose operation does not correspond with the foregoing provisions.
- (5) The pilot shall possess the appropriate ratings for the aircraft and shall be competent to safely conduct the assigned tasks. The pilot shall have the final authority and is solely responsible for the safe operation of the helicopter load at all times.

9.02 Equipment and Tools

- (1) All equipment and tooling shall be free from defects, and in accordance with manufacturers specification for continued serviceability. Each day, rigging shall be visually inspected by the pilot and men performing the work. If deficiencies are found, the item shall be discarded unless repairs can be made to return its condition to like new quality.
- (2) Helicopters shall be FAA certified for work to be performed. Pilots shall be qualified under FAR Part 133, Class A, B, & C as applicable and must be proficient and current in task to be completed.

- (3) Helicopter maintenance shall be done in accordance with manufacturer's recommendations and the FAA.
- (4) A pre-flight inspection of the helicopter shall take place each day prior to any work being done. A pilot's checklist shall be completed daily. A copy of the checklist shall be kept in the aircraft at all times. Long lines used to carry loads shall be inspected daily and replaced immediately should any damage occur beyond manufacturer's allowable limits. Communication shall be operable at all times from helicopter to helicopter, helicopter to workmen working below and pilot to passenger. If communications are interrupted, operations shall cease until they are restored.

9.03 Receiving Loads While Working Aloft

Cargo Hooks

- (1) All cargo hooks shall have a primary and secondary release mechanism designed and installed as to prevent inadvertent operation. The hooks primary and secondary release shall be tested prior to each day's operation to determine that the release functions properly.
- (2) No employee shall be permitted to work under a hovering helicopter(s) unless the cargo hooks used comply with Federal Aviation Administration regulations governing such hooks.

Hooking and unhooking

- (1) Work performed at an elevated position and directly under hovering helicopters shall be performed only by qualified and capable employees.
 - (a) Work shall be limited to minimum time necessary to guide, secure, hook or unhook the loads
 - (b) When an employee is working from the ground under hovering helicopters, the employee shall have a safe means of ingress and egress at all times, including a readily available escape route or routes in the event of an emergency.
- (2) Positive guide systems shall be used for the placement of large segments of primary tower structure and shall enable the heavy lift helicopter to temporarily secure and release the load. Bolting of or otherwise permanently securing the structures is prohibited under hovering helicopters except that in the event of an unforeseen contingency of an emergency nature which represents a substantial hazard to life or property, an employee may do such work as is necessary to preserve life or protect substantial property.

Sling and rigging

- (1) The pilot is responsible for the integrity of the rigging for any external load and must ensure safe delivery of the cargo by inspecting and monitoring the security of the rigging throughout the operation. Prior to operations, the pilot must check the condition and application of all rigging gear to ensure serviceability. Prior to commencing operations, determine the complete rigging requirements, including slings and taglines.
- (2) All personnel involved with rigging activities must receive appropriate rigging training and show proficiency specific to helicopter operations and the work tasks being performed.
- (3) The slings used for the external load must be inspected each day before use. Slings must be inspected by an employee designated, trained and qualified as a rigger.
- (4) No sling shall be used unless it has a properly marked minimum tensile strength of five times the load which will be carried or is being carried.

- (a) No sling shall be used unless upon inspection it is determined to be in good condition and capable of the work which is to be performed and properly marked.
- (b) Loads must be properly slung so that there will be no slippage or shifting of the load and so that the load will not accidentally be dislodged from the helicopter.
- (c) In an energized environment helicopter load lines must be comprised of nonconductive materials which are the appropriate weight, strength, and length to prevent the line from being lifted and entangled into the aircraft rotor system.
- (d) Pressed sleeves, wedged eyes, or equivalent means shall be used for all suspended loads utilizing wire rope. All eyes on synthetic line shall be produced by the line manufacturer or a certified splicer for the specific type of line.

9.04 Cargo Loading and Handling

- (1) All cargo shall be loaded and secured under the direction of the pilot or pilot's designee.
- (2) No passenger shall be transported in the helicopter with a sling load and no person shall be transported as an external or sling load, except in accordance with 14 CFR 133.35, and FAA authorization of HEC.
- (3) Explosives and other "dangerous materials" shall not be transported except by FAA under "will carry" authorized, and special permit issued PHMSA and F.A.A.
- (4) All sling loads, including line-stringing devices, shall be attached only to quick-release devices. Steel or metallic sling ends shall be of the pressed sleeve or swaged eye-type, or equivalent. Tag lines shall be of a length or secured in such a manner that will not allow their being drawn up into the rotors.
- (5) External sling load operations shall not be performed if electrical storms in the immediate vicinity make the work unsafe.
- (6) Load landing operations shall not be performed when the pilot or ground crew deems the wind conditions are unacceptable.

Helicopter Line Stringing

- (1) Weight of the external load shall not exceed the manufacturer's load limit.
- (2) Each helicopter operator utilized in line stringing shall be authorized by the Federal Aviation Administration, Part 133, Class C Operations.
- (3) All line stringing operations shall be conducted in accordance with the following requirements:
 - (a) Stringing tension method shall enable a consistent positive control of the cable, rope, or similar lines at all times during pulling operations; During all pulling operations, the helicopter pilot shall maintain an aircraft orientation that allows the pilot to maintain constant visibility in both directions online;
 - (b) When pulling from the aircraft belly hook attachment point, a ballast weight of a minimum three hundred pounds shall be utilized;
 - (c) At no time during the pulling operation shall the load line that is attached to helicopter's belly hook attachment point exceed a thirty-degree angle from vertical.

- (d) A helicopter shall not pull any cable, rope, or similar line which is at any point attached to a fixed object other than the helicopter itself. Helicopters may pull a “free-wheeling” or “pay-out” of the cable, rope, or similar line so long as the end is not tied to a truck or fixed object other than the reel itself.
- (4) When stringing lines or conductors, there shall be radio communication between the helicopter and the ground crew.
- (5) When stringing lines or conductors close to or parallel to energized lines, conductive lines or reels, payout machines, and conductors shall be grounded as required by the High Voltage Electrical Safety Orders. Hoist wires or other gear shall not be attached to any fixed ground structure. EXCEPTION: When pulling lines or conductors that are allowed to "pay-out" from a container or roll off a reel.

9.05 Helicopter Skid and Tower Aerial Hover Transfer

- (1) Full body harnesses, lanyards, hardware, and attachment points must meet the requirements in ANSI Z359.1-2007
- (2) All employees transferring from a helicopter to a structure/conductor must wear a full body harness and lanyard fixed to an approved attachment point on the helicopter, structure/conductor. An ANSI approved device that allows the worker to be attached simultaneously to the helicopter and the structure/conductor shall be used until the transfer is complete.
- (3) Fall protection must be established and maintained one hundred percent during the entire time the employee is transferring from the helicopter to or off the structure/conductor.
- (4) After the linemen are belted on to the helicopter via the attach points with the shock lanyard, positioning belt and the proper tools and hardware for the job loaded onboard, the pilot will maneuver the helicopter next to the structure so that the linemen can place his tools and hardware on the structure and then transfer himself to the structure.
- (5) The rear door shall be removed, and the linemen must attach to a Class A external load attachment point approved by the FAA for external cargo operations.

On steel structures up to 2 workers may be transferred at the same time provided the pilot and lineworkers all agree that it is safe to do so. If anyone feels it is not safe to perform this method on any particular job or location, then the method shall be modified to limit the transfer to 1 worker at a time.

- (6) On wood poles this method will always be limited to 1 worker at a time.
- (7) All structures shall be bonded by cable to the helicopter prior to the lineman transferring between the helicopter and the structure. Such bonding will be done utilizing approved cables with spring loaded quick release clamps.
- (8) It is extremely important, that whatever the helicopter is bonded to must be the same object that the lineman transfers on to. In the case of an isolated static system, grounds from the structure to the wire shall be used if the Lineman cannot safely transfer without contacting the static. If this is the case then the helicopter should be bonded to the wire and then the wire grounded to the structure, in that order.
- (9) Once the helicopter is properly bonded and if necessary, the structure’s static grounded, the lineman is ready to start transferring equipment and material to the structure. Every piece of equipment shall be placed onto the structure in a way so as to prevent any contact with the lower phases. Handlines, hoists, grounds, splices, cables all have the potential to come into contact with the phases and must be secured in a

manner to prevent inadvertent release. Everything should be placed in a manner that does not interfere with the hand and footholds that will be used for the lineman transfer.

- (10) If followed, these guidelines will minimize the risks involved in these procedures. Again, before the flight begins is the time to analyze a particular situation. If a special condition exists, you may have to deviate slightly to gain more safety, but it should be an exception.

9.06 Working from the Helicopter Skid

- (1) Linemen must use an ANSI approved safety harness.
- (2) The rear door shall be removed, and the lineman must attach to a Class A external load attachment point approved by the FAA for external cargo operations.
- (3) Aircraft CG limits must be observed.
- (4) Aircraft performance and controllability must not be in question prior to the task to be performed. In the case of adverse wind angles, the helicopter will be positioned in the approximate position desired and checked for controllability.
- (5) **STATIC DISCHARGE:** If the purpose of the lift is to place the lineman onto the tower, then the potential static charge will be dissipated by touching the skid to the tower. If the purpose of the lift is to work on an ungrounded item, such as conductor wire or static wire, then the lineman will evaluate the situation and use either hot gloves or jumper cables to bond the helicopter. Jumper cables, once attached, shall be able to be removed with minimal force so as to allow the helicopter to maneuver away if needed.

9.07 Helicopter Rules for Human External Cargo (HEC)

- (1) Incorporated hereto by reference is the Helicopter Rules for Human External Cargo (HEC) that was approved on December 1, 2010
- (2) Human External Cargo (HEC).
 - (a) The sling/vertical suspension system (human external cargo or HEC) is a vertical system suspended from the helicopter cargo hook. The aircraft attaching means shall comply with all governmental requirements (e.g., 14 C.F.R. Part 133, Class B or D – External Load). For Class B & D operations the aircraft attaching means shall also comply with 14 C.F.R. 27.865 or 29.865. Helicopter operators involved in HEC must have an FAA approved Rotorcraft Load Combination Flight Manual (RLCFM) that includes specific approval for HEC.
 - (b) Helicopter operations involving HEC shall incorporate the use of a secondary safety device, in addition to the helicopter's primary attachment means, to prevent the inadvertent release of the load. This device shall remain jettison-able in accordance with Class B load requirements.
 - i. All lines utilized for HEC operations shall be dedicated for HEC and shall not be used for transporting cargo.
 - ii. HEC lines shall not be less than 10:1 safety ratio between the rated breaking strength and the working load.
 - iii. All harnesses utilized for helicopter HEC operations must meet the ANSI Z359.1-2007 standards for class III (full body) harnesses and must be equipped with both dorsal and sternal D rings.

- iv. All suspension harnesses used for HEC must be adjusted to the user. The harness must be designed to prevent suspension trauma or equipped with an orthostatic shock relief device. Such devices must be deployed and used if an employee has been in suspension longer than five minutes.
- (c) External platform skid operations. If a platform system is used to transport crews or where a crew member performs work from the platform system and all aircraft attachments shall comply with applicable FAA regulations and requirements. All platform operations shall be conducted in accordance with the 14 C.F.R. Part 133, Class A – External Load. Flight and hovering capabilities of the helicopter must not be adversely affected by the design of the platform. The platform must not affect the auto rotation and emergency capabilities of the helicopter. The platform and loads may affect the lateral and longitudinal CG weight and balance of the helicopter in flight. An engineered counter-balance must be used if the platform exceeds the lateral CG limits of the manufacturer’s specifications for the helicopter which will ensure stability.
- (3) External cargo sling loads

Helicopter longline support operations (cargo operations) shall only be performed by qualified, competent and trained personnel. All operations shall be conducted in accordance with applicable Federal Aviation Administration regulations.

All external load operations, in addition to the above-mentioned regulations shall also comply with the Helicopters Association International, Utilities, Patrol and Construction Committee guidelines (latest version).

General

No Employee will be required to perform or undertake helicopter line worker activities. Helicopter line work shall be performed by volunteer line workers only. No employee shall be discriminated against who refuses to volunteer for this work.

Before each flight, the supervisor in charge, the pilot, and the helicopter line workers(s) must analyze and address any conditions specific to the work situations and agree on the safety measures required to address those conditions. When determining and selecting the best method to use, the supervisor in charge, the pilot, and the helicopter line workers(s) must ensure that safe distances can be maintained between all parts of the helicopter and any energized conductors, de-energized conductors, coworkers and/or the structure.

If, at any time either before performing the work or while performing the work, the helicopter line workers(s), the supervisor in charge, or the pilot, in his or her opinion, believes that dangerous or unsafe conditions exist that could jeopardize the safety of the operations, the helicopter line workers supervisor in charge, or pilot has the right to postpone or stop the operation until those safety concerns have disappeared or have been corrected. These conditions include, but are not limited, to the following.

- ✓ Inclement weather conditions
- ✓ Insufficient Clearances
- ✓ Exceeding Helicopter load limits
- ✓ Structure or Conductor damage that causes a safety concern
- ✓ Any other condition that may adversely affect the safety of the operation.

“Pilot in Command” means the person who –

- (1) Has final authority and responsibility for the operation and safety of the flight;
- (2) Has been designated as pilot in command before or during the flight; and
- (3) Holds the appropriate category, class, and type rating, if appropriate, for the conduct of the flight

Equipment/PPE

Personal protective equipment when working on, under or in the near vicinity of helicopters:

- (1) All employees shall wear eye protection of such design as to prevent the likelihood of dust or other substances from contacting the eye(s) of employees.
- (2) The person in charge must perform and document a hazard assessment to identify and determine the appropriate PPE for the work being performed, the location and site and/or equipment.

Wearing apparel

No employee shall wear clothing or apparel which is either designed to or in fact can reasonably be expected to flap or otherwise react in a similar fashion in the downwash or air disturbance of a helicopter(s). No employee shall work on, under or in the near vicinity of a helicopter while wearing such apparel or clothing which flaps or moves to the extent that it presents a hazard in that it could be caught in the moving equipment, the hoist line, or otherwise interfere with the safe performance of the work.

Loose gear and objects

All loose gear, including lunch boxes, rope, cardboard, wire covers, and similar items shall be removed or secured or otherwise made fast before the helicopter is started or allowed to approach such area. In the event the gear is not secured or fastened, it shall be removed and located outside the downwash at least 100 feet from the helicopter.

Head Protection

All helicopter line works must use an ANSI Z89.1, Type 1, Class E, approved helicopter helmet or Hard Hat equipped with a 3-point chin strap securely fastened. Every precaution must be taken to prevent the possibility of a hard hat or helmet from being blown off and contacting the helicopter rotor blades.

Fall Protection:

The helicopter line workers shall be attached 100% of the time to an approved anchorage point while working as an external load. Workers shall either wear a rope access type harness or a combination lineman's body belt and full body harness both equipped with a work positioning strap and shock absorbing lanyard. All lanyards and positioning straps used by helicopter line workers must be positioned to prevent possible hang-ups while transferring to and from a structure and while egressing the tower or landing zone.

When work is to be performed while hanging from a long-line and not just for the purpose of transporting the worker to the structure and/or conductor, the use of a boatswains chair shall be required.

Hearing Protection:

Helicopter line workers must use either approved hearing protection or an approved flight helmet or gear while working from a helicopter. All ground-support personnel must wear adequately rated hearing protection while working near helicopters.

Visual Inspections:

Visual inspection of supporting the structures and conductors shall be performed by the lineworkers prior to transferring any worker from the helicopter to the structure or conductor to identify any condition that might jeopardize a line worker's personal safety or raise concern for the helicopter line worker, the supervisor in charge, or the pilot. Any unsafe conditions that are discovered during the inspection process must be corrected before performing the helicopter line-work procedures. If these conditions cannot be corrected, use an alternate work method.

Helicopter operation

- (1) Whenever approaching or leaving a helicopter with blades rotating, all employees must remain in full view of the pilot and remain in a crouched position while within 50 feet of the helicopter. No employee may approach the rear of the helicopter unless directly authorized and directed by the pilot of such craft. All employees when operating or working within 50 feet of the helicopter with blades turning are subject to the direction of the helicopter pilot.
- (2) All materials and equipment loaded in the aircraft shall be properly secured for flight.
- (3) Long objects, such as shovels and hot sticks, shall be carried horizontally and below the waist to avoid contact with the aircraft rotor blades.
- (4) The pilot shall ensure that all loads are safely secured to the helicopter or in cargo baskets and properly loaded with regard to weight and balance.

No tools shall be carried in on the lineworkers body belt that could fall out during transport. Any tools that could fall off the belt must be secured by a lanyard. Tools that could impede the lineworkers movements or that could hang up on the helicopter or the structure should also not be carried by the lineworker.

- (5) Never throw anything while loading and unloading the helicopter. Thrown items may come in contact with the aircraft rotor blade, causing damage to the aircraft and possible injury to ground personnel.
- (6) While in the helicopter, safety belts must remain fastened at all times except when the pilot instructs otherwise or while entering or leaving the helicopter.
- (7) Smoking in the helicopter is prohibited at all times.
- (8) No employee shall ride in or work under or near a helicopter with less than twenty minutes reserve fuel.
- (9) No employee shall attempt to slow or stop the rotorcraft blades.

Helicopter work tasks

- (1) **Aerial hover transfer**
 - (a) Full body harnesses, lanyards, hardware, and attachment points must meet the requirements in ANSI Z359.1-2007.
 - (b) All employees transferring from a helicopter to a structure/conductor must wear a full body harness and lanyard fixed to an approved attachment point on the helicopter, structure/conductor. An ANSI approved device that allows the worker to be attached simultaneously to the helicopter and the structure/conductor shall be used until the transfer is complete.
 - (c) Fall protection must be established and maintained one hundred percent during the entire time the employee is transferring from the helicopter to the structure/conductor.

Fly Yards or other Landing Zone Locations

Fly yards or other landing zone locations used for helicopter line-work must be located as close as practical to the area work is to be performed. All efforts shall be made to limit any worker from being transported via HEC or skid for more than 10 minutes fly time.

(1) **When establishing the landing zone, the following items shall be considered:**

- Size and type of helicopter;
- Suitability of the planned activity;
- Physical barriers or obstructions;
- Helicopter touch down area and congestion in the area.

(2) All helicopter landing, loading and unloading areas shall be maintained in a neat and orderly fashion so as to reduce the likelihood of flying materials, tripping, or other hazards attendant to the work being performed.

Before each flight begins, the pilot, the supervisor -in-charge and the helicopter line worker must analyze and address specific work conditions and agree on the safety measures to take when addressing those conditions.

If a special condition exists, it may be necessary to adjust these procedures slightly to provide a greater margin of safety. Adjustments to these procedures should be considered only as a temporary exception for the duration of the special condition. If changes occur an additional tailboard is required to address all such changes to the operation.

Grounding

When the requirements to perform this work dictate that the line be grounded, refer to the grounding section of the NECA/IBEW safety manual (Red Book). Employees must follow all applicable protective grounding rules before performing any work.

Static charge

All loads shall be grounded or bonded with a device capable of discharging either the actual or potential static charge before ground personnel either touch or come close enough to touch the suspended load.

Visibility

Employees shall keep clear of and outside the downwash of the helicopters except as necessary to perform a permitted activity. Where reasonably practical, reduced vision of the operator and ground crew shall be eliminated.

Communications

Communications between the lineworker and pilot may be in the form of hand signals, head signals, direct verbal communication, or when practical the use of radio communications. If radio communications are used each employee must also be proficient in the other forms of communications in case of equipment malfunction.

- (1) Communication must be maintained between the air crew and ground personnel at all times by a designated and qualified signalperson. There must be a constant, open line of communication using radios or head and hand signals.
- (2) Signal systems must be understood by the air crew and the ground crew, including signalpersons, prior to the hoisting of any load.

- (3) Signaling and maintaining communications with the pilot will be exclusive to the designated signalperson during periods of loading and unloading. The signalperson must be distinguishable from other members of the ground crew by the pilot of the aircraft. This may be by way of orange-colored gloves, vest, or other apparel.
- (4) The lead worker and one crew personnel must also have an operating transmitter and receiver.
- (5) Authorized and qualified employees may come within 50 feet of the helicopter when the rotor blades are turning, but no closer, other than to enter the aircraft or to hook or unhook the load or do other essential functions. Other employee(s) shall not come closer than 100 feet of the aircraft when it is operating.
- (6) The signal between the signalperson and the operator of the helicopter shall be those submitted to the FAA for the particular job. When head signals are to be used, the qualified worker must utilize a visually enhanced hard hat or helmet with clear markings to indicate the desired movement. Any signals other than up/down in/out will require the use of hand signals.
- (7) Should there occur a change in the hazards, methods of performing the job, signals to be used, or other operating conditions during the course of any particular job, a conference shall immediately be held at which time all affected employees and others (including signalpersons, ground workers, and pilots) will be advised of such hazards or change of operation. No employee shall be permitted to work unless such employee and others fully understand and changes that have taken place.

When using head signals the lineman must have a visually enhanced hard hat or helmet with clear markings to indicate the desired movement. Any signals other than up or down will require the use of hand signals.

HELICOPTER HAND SIGNALS

MOVE RIGHT



Left arm extended horizontally; right arm sweeps upward to position over head.

HOLD- HOVER



The signal "Hold" is executed by placing arms over head with clenched fists.

MOVE LEFT



Right arm extended horizontally; left arm sweeps upward to position over head.

TAKEOFF



Right hand behind back; left hand pointing up.

MOVE FORWARD



Combination of arm and hand movement in a collecting motion pulling toward body.

LAND



Arms crossed in front of body and pointing downward.

MOVE REARWARD



Hand above arm, palms out using a noticeable shoving motion.

MOVE UPWARD



Arms extended, palms up; arms sweeping up.

RELEASE SLING LOAD



Left arm held down away from body
Right arm cuts across left arm in a slashing movement from above.

MOVE DOWNWARD



Arms extended, palms down; arms sweeping down.

Fires

Open fires shall not be permitted in any area in which said fires will be affected by the downwash of the rotors, nor shall any employee smoke in an area subject to the downdraft of the rotor.

Refueling operations

- (1) Refueling of any helicopter with either aviation gasoline or Jet B (Turbine) type fuel shall be prohibited while the engines are running.
- (2) Fueling of helicopters using Jet A (Turbine-Kerosene) type fuel is allowed with engines running.
- (3) All helicopter fueling must comply with the following:
 - (a) No unauthorized persons shall be allowed within fifty feet of the refueling operation or fueling equipment.
 - (b) A minimum of one thirty-pound fire extinguisher good for class A, B and C fires, shall be provided within one hundred feet on the upwind side of the refueling operation.
 - (c) All fueling personnel shall be thoroughly trained in the refueling operation and in the use of the available fire extinguishing equipment they may be expected to utilize.
 - (d) There must be no smoking, open flames, exposed flame heaters, flare pots, or open flame lights within fifty feet of the refueling area or fueling equipment. The refueling area or the fuel truck must be posted with "NO SMOKING" signs.
 - (e) Prior to making any fueling connection to the aircraft, the fueling equipment shall be bonded to the aircraft by use of a cable, thus providing a conductive path to equalize the potential between the fueling equipment and the aircraft. The bond shall be maintained until fueling connections have been removed, thus allowing separated charges that could be generated during the fueling operation to reunite. Grounding during aircraft fueling shall not be permitted.
 - (f) To control spills, fuel shall be pumped either by hand or power. Pouring or gravity flow shall not be permitted. Self-closing nozzles or deadman controls shall be used and shall not be blocked open. Nozzles shall not be dragged along the ground.
 - (g) In case of a spill, the fueling operation shall be immediately stopped until such time as the person-in-charge determines that it is safe to resume the refueling operation.
- (4) Helicopters with their engines stopped being refueled with aviation gasoline or Jet B (Turbine) type fuel, shall also comply with subsection (3)(a) through (g) of this section.

Training Requirements

Training for line-workers who voluntarily choose to use this work method will consist of both General training established or approved jointly by NECA and the IBEW as well as site specific training that will be performed by the contractor and Helicopter Company performing the work.

GOOD AND BAD RIGGING PRACTICES

Use of Chokers



Good

No cutting action on running lines



Good



Bad—Because of cutting action of eye splice on running line



Bad—Bolt on running line can work loose

Eye Splices



Good Practice—
Note use of thimble in eye splice

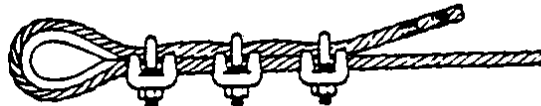

Good Practice—
Use of thimble in eye splice

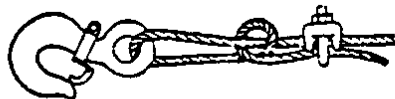

Bad Practice—
Wire rope knot with clip.
Efficiency 50% or less

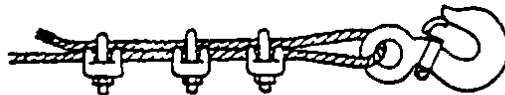

Bad Practice—Thimble should be used to increase strength of eye and reduce wear on rope

Hook Slings

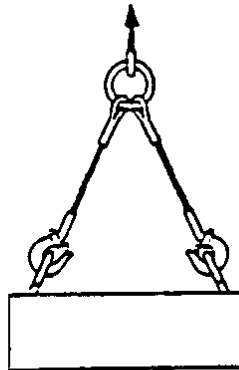

Bad Practice—
Hook openings should be turned out

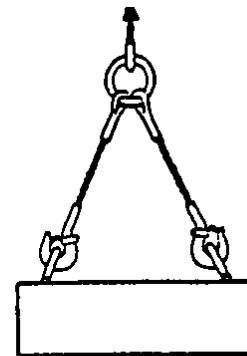

Good Practice—
Hooks are turned out

GOOD AND BAD RIGGING PRACTICES

*Double slings shall be used when hoisting
2 or more pieces of material over 12 feet long*

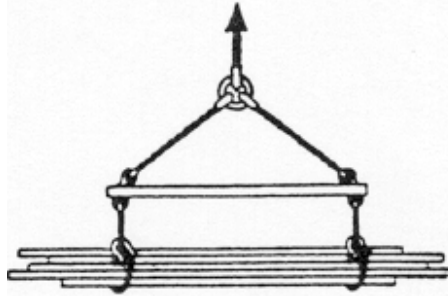

Right—Load over 12' long



Wrong—Load over 12' long



Vertical lift
on eyebolt is
good practice

Eye Bolts

Bad Practice—Lifting on
eye bolts from an angle
reduces safe loads as
much as 90%



Suspending Needle Beams or Scaffolds

Hoisting Structural Steel



Bad Practice—
Can bend flanges
and cut rope



Good Practice—
Use space blocks
and pad corners



Bad Practice—
Steel can cut rope



Good Practice—
Sharp corners
padded

APPLICATION OF WIRE ROPE U-BOLT CLIPS Crosby Type

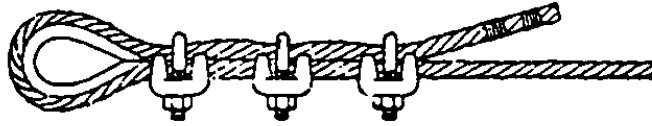

1. **CORRECT METHOD**—U-Bolts of clips on short end of rope.
(No distortion on live end of rope.)

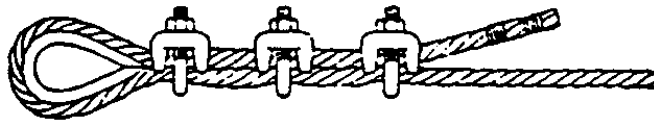

2. **WRONG METHOD**—U-Bolts on live end of rope.
(This will cause mashed spots on live end of rope.)

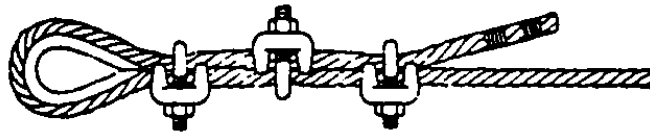

3. **WRONG METHOD**—Staggered clips; two correct and one wrong.
(This will cause a mashed spot in live end of rope due to wrong position of center clip.)
4. After rope is in service, and is under tension, tighten clips to take up decrease in rope diameter.



Number of Crosby or Safety Clips and Distance Between Clips Needed for Safety

Diameter of Rope (Inches)	Number of Clips	Distance Between Clips
$\frac{3}{16}$ — $\frac{3}{8}$ Inc.	3	Distance between clips should be 6 times the nominal diameter of the cable.
$\frac{3}{4}$ — $\frac{7}{8}$ Inc.	4	
1	5	
$1\frac{1}{8}$ — $1\frac{1}{4}$	6	
$1\frac{3}{8}$ — $1\frac{1}{2}$	7	

SCREW PIN, ROUND PIN AND BOLT TYPE ANCHOR SHACKLES FORGED STEEL — SAFE LOAD IN POUNDS

*Shackle size	*Safe Working Load—Pounds	Length Inside Inches	Width Between Eyes—Inches	*Diameter of Pin—Inches
	1000	1½	½	⅜
	2000	1¾	⅝	⅜
	4000	1¾	⅝	¾
	6500	2¾	1⅛	¾
	9500	2¾	1¼	¾
	13000	3¾	1⅛	1
	17000	3¾	1⅛	1¼
	19000	4¼	1⅛	1¼
	24000	4¾	2⅝	1¾
	27000	5¾	2¼	1½
	34000	5¾	2⅝	1¾
	50000	7	2¾	2
	70000	7¾	3¼	2¼

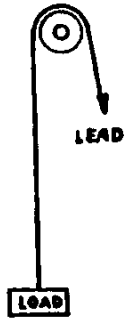
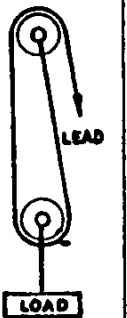
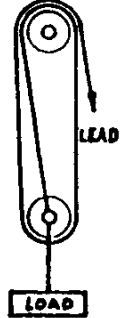
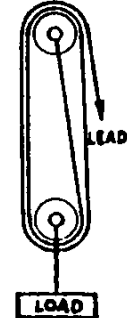
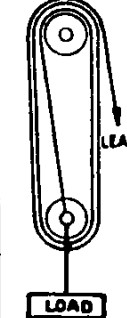
*These values also apply to screw pin, round pin and bolt type chain shackles.

SAFE LOAD OF NEW COMBINATION SYNTHETIC (SPEC. #1) AND LIVE LINE ROPE (SPEC. #4) AND TACKLE IN POUNDS								
Diam. Rope Inches	Min. Size Blocks Inches	Straight Pull	1 Part Fall 1 Single Block	2 Part Falls 2 Single Blocks	3 Part Falls 1 Single 1 Double Block	4 Part Falls 2 Double Blocks	5 Part Falls 1 Double Block 1 Triple Blk.	6 Part Falls 2 Triple Blocks
								
½	4	650	591	1074	1466	1781	2019	2203
¾	6	1300	1182	2149	2932	3562	4037	4407
1	8	2200	2000	3636	4962	6027	6832	7458
1¼	12	3300	3000	5455	7444	9011	10249	11186

These values may be reduced by the strength of the blocks, hooks, shackles and anchor points that are used.

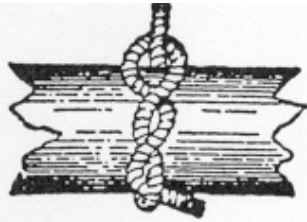

Timber Hitch

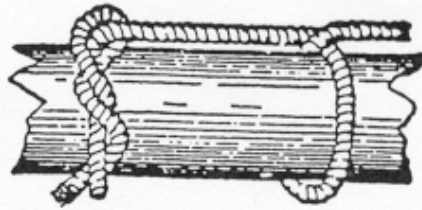

Timber Hitch and Half Hitch

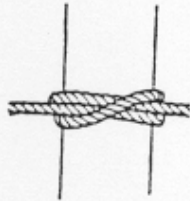

Clove Hitch



Square or Reef Knot

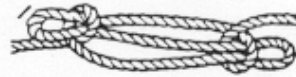

Sheepshank



Stopper Hitch

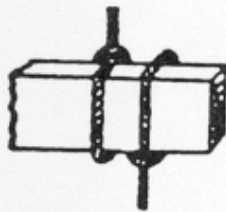

Scaffold Hitch



Bowline



Running Bowline



Becket Knot

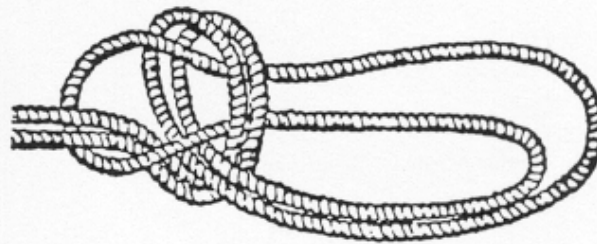

Bowline on a Bight

* Each fiber in the straight part of a rope takes its proper share of the load. If a knot or hitch of any kind is tied in a rope, its failure under stress is sure to occur at that point. The values given below are approximate, but must be considered when making rope attachments.

APPROXIMATE EFFICIENCY OF KNOTS IN A PERCENTAGE OF THE FULL STRENGTH OF THE ROPE

	Rope Dry. Average of Tests from the Same Coil as the Knots.	Eyesplice over an Iron Thimble.	Short Splice in the Rope	Timber Hitch, Round Turn, and Half-hitch.	Bowline Slip Knot Clove Hitch.	Square Knot, Weaver's Knot, Sheet Bend.	Flemish Loop, Overhand Knot.
The efficiency of the knot	100	90	80	65	60	50	45